



SHENZHEN GROWATT NEW ENERGY CO., LTD.

4-13/F, Building A, Sino-German (Europe) Industrial Park,
Hangcheng Ave, Bao'an District, Shenzhen, China

T + 86-755-27471900
E info@ginverter.com
W www.ginverter.com

Growatt THOR 11AS-S/P
Growatt THOR 22AS-S/P

Three-phase AC charger user manual

Disclaimer

This user manual is copyrighted by Growatt New Energy Co.,Ltd.(Hereinafter referred to as "Growatt"). No company or person may extract or copy part or all of this user manual without the written permission of Growatt. Content must not be transmitted in any form, including materials and publications.

All rights reserved. Growatt has the final right to interpret this user manual. The information in this manual is subject to change without notice.

Thank you for using Growatt EV charging pile!

THOR series intelligent three-phase AC charger is a power supply device that uses professional and advanced technology to provide energy supply to electric vehicles, it also has a friendly man-machine interface and versatile functions of control, billing, and communication. The charger can be connected to a back-office server to realize the functions of reservation and payment via Mobile phone APP. Diversified communication options, including wired Ethernet, WIFI, 4G is available for back-office server connection.

We sincerely hope that this product can meet your needs and will continuously improve the quality of our products.

Menu

- I. Product description 1
- II. Packing list 3
- III. Installation and wiring 4
- IV. APP download, register, and login 8
- V. EV Charger Internet Configuration 13
- VI. Operation instruction and LCD description..... 24
- VII. EV Charger Work Modes 28
- VIII. Other Settings 39
- IX. Record..... 41
- X. Data 43
- XI. Troubleshooting 44
- XII. Specification 45
- XIII. Annex 46

I. Product description

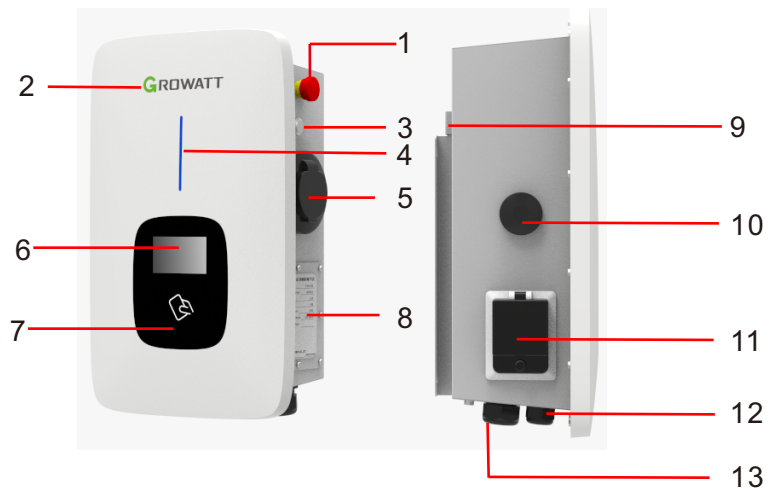

- | | |
|---|--|
| 1. Emergency stop button | 9. Mounting bracket; |
| 2. LOGO and LOGO backlight; | 10. WIFI/4G antenna; |
| 3. Forced on/off button; | 11. Side window |
| 4. Status indicator
(Indicator flashes when charging); | 12. Waterproof cable gland for
communication wires; |
| 5. Socket outlet(plug holder for
cabled version); | 13. Waterproof cable gland for
AC input cables |
| 6. LCD screen | |
| 7. Swipe card | |
| 8. Name plate | |

Wiring definition in the side window

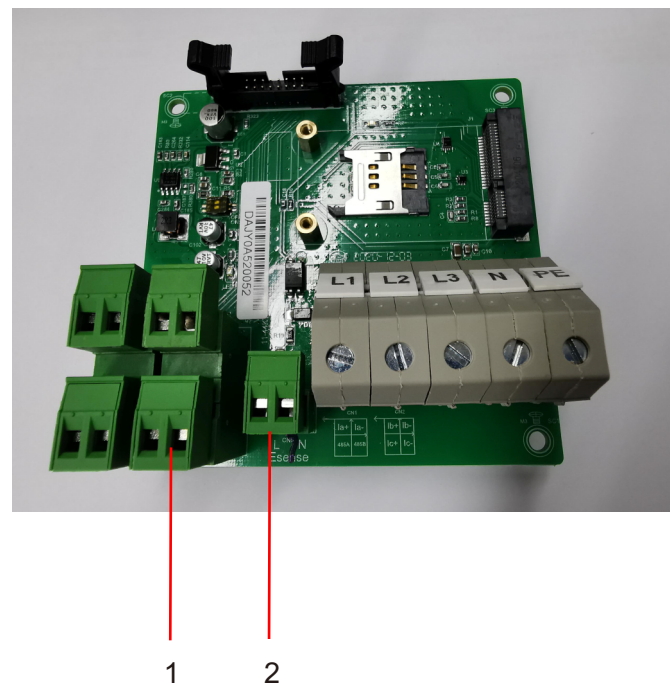

1. Terminal block for CT/meter wiring. The terminal definition is:
485A/485B is RS485 terminal for meter connection;
la+/la- , lb+/lb-, lc+/lc- is for CT connection
2. Peak&Off Peak Charging Enable signal is:
eSense L/N

II. Packing list

No.	Name	Qty	Remark
1	Charger	1	
2	User manual	1	
3	Quality certificate	1	
4	Mounting bracket	1	
5	Cable hook	1	For cabled version
6	ST6.3X40 Stainless steel hex-head self-drilling screws	4-7	4 for socket version, 7 for cabled version(3 of the 7 screws is for cable hook fixing)
7	12X46 Plastic expansion plugs	4-7	4 for socket version, 7 for cabled version(3 of the 7 plugs is for cable hook fixing)
8	User card	1	RFID function will be equipped with user card

III. Installation and wiring

3.1 Mount on a wall

3.1.1 Open the package, you'll see a charge point, a mounting bracket, a user manual and a bag of mounting accessories. There is also an RFID card if the charge point is RFID version. For cabled version, a cable hooker is also included inside.

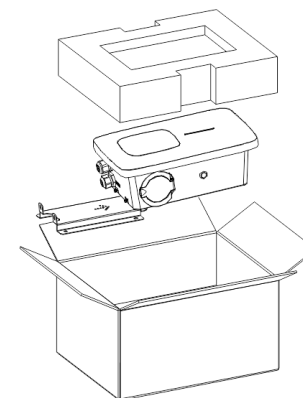

3.1.2 Remove the mounting bracket from the charge point, use it as a template to mark the position of the drill holes. Drill the holes and hammer the expansion bolts in the accessories bag into the holes. Then fix the mounting bracket onto the wall.

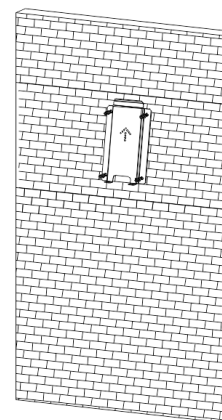

3.1.3 Put the charge point onto the bracket, and fix it with the 2 screws at the bottom of the charge point. The installation is done.

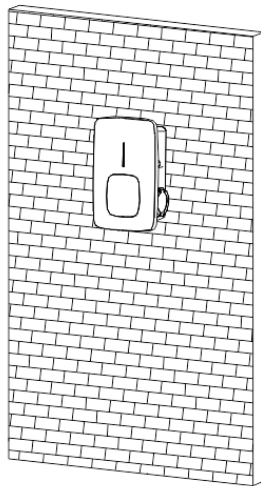

3.1.4 Crimp the below shown insulated ferrule or ring terminals on the end of the AC input wires. Connect the wires into the terminal block of the charge point as below. Check the wiring and then close the RCBO in the side window. Close the side window with the cover, then the wiring is done.

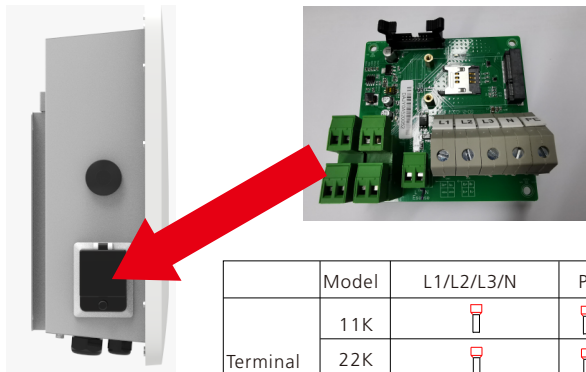

	Model	L1/L2/L3/N	PE
Terminal	11K		
	22K		
	44K		
Wire	11K	$\geq 2.5\text{mm}^2$ $\geq \text{AWG}12$	$\geq 2.5\text{mm}^2$ $\geq \text{AWG}12$
	22K	$\geq 6\text{mm}^2$ $\geq \text{AWG}9$	$\geq 6\text{mm}^2$ $\geq \text{AWG}9$
	44K	$\geq 16\text{mm}^2$ $\geq \text{AWG}5$	$\geq 16\text{mm}^2$ $\geq \text{AWG}5$

3.2 Mount on a pole

3.2.1 Open the package of the pole, take out the pole and mounting accessories.

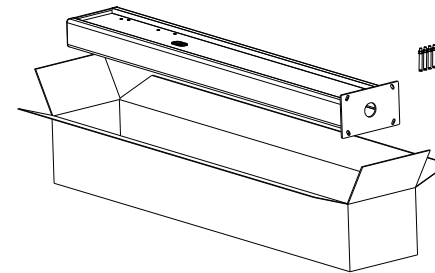

3.2.2 The pole must be installed on a hard surface, concrete surface is recommended, it can also be mounted on a solid ground. Drill holes according to the requirements marked on the illustration for fixing expansion bolts.

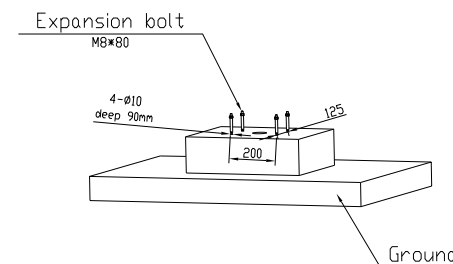

3.2.3 Fix the pole onto the holes with expansion bolts. The input cables shall go into the pole from the bottom middle area and come out of it from the area below the cable hooker.

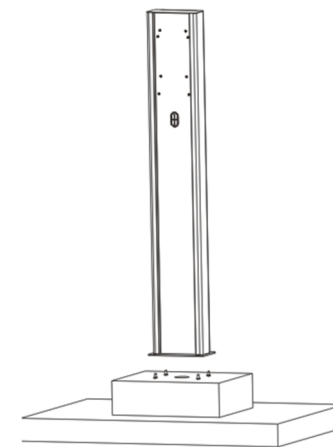

3.2.4 Fix the mounting bracket onto the pole.

3.2.5 Position the charge point onto the bracket and secure it on the bracket with the 2 screws.

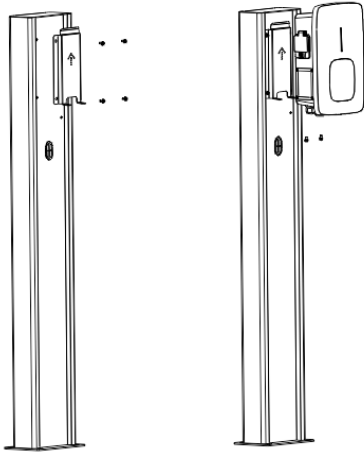

3.2.6 Crimp the below shown insulated ferrule or ring terminals on the end of the AC input wires. Connect the wires into the terminal block of the charge point as below. Check the wiring and then close the RCBO in the side window. Close the side window with the cover, then the wiring is done.

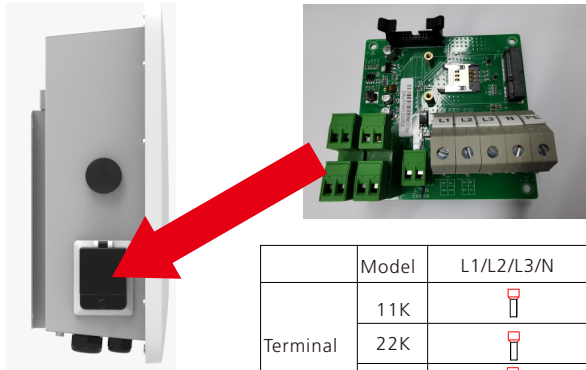

	Model	L1/L2/L3/N	PE
Terminal	11K		
	22K		
	44K		
Wire	11K	$\geq 2.5\text{mm}^2$ $\geq \text{AWG}12$	$\geq 2.5\text{mm}^2$ $\geq \text{AWG}12$
	22K	$\geq 6\text{mm}^2$ $\geq \text{AWG}9$	$\geq 6\text{mm}^2$ $\geq \text{AWG}9$
	44K	$\geq 16\text{mm}^2$ $\geq \text{AWG}5$	$\geq 16\text{mm}^2$ $\geq \text{AWG}5$

IV. APP download, register, and login

4.1 APP download

Users can scan the QR code (Android and IOS) with the WeChat, or go to the App Store and Google Play to search for ShinePhone or log in to our monitoring website server.growatt.com or server-cn.growatt.com to download.



4.2 Register

Before using ShinePhone APP first time, the user must register an account in advance.

There are three steps when users register the account:

(1) Fill in the account registration information.

a) Fill in the account information. To fill in the account information, you need to select the account country (required), fill in the user name (required), password (required), confirm password (required), telephone (required in China, optional for other regions), email (optional in China, required for other regions), installer code (optional).

b) The user terms must be checked manually to agree before registering, all required fields must be filled in before registering.

(2) Add Plant

Add Plant Skip

* **Plant name** Enter the Plant name

* **Installation date** Select the installation date

Plant address

* **AlandIslands** **City**

Please enter the full address

Longitude Latitude

* **Time zone** +08

* **PV capacity(W)** PV capacity

* **Plant type**

(Conversion standard based on 1kWh power generation)

Fund Revenue **DOLLAR**

PV Plant picture Upload Picture

a) When customers add plant, they need to fill in the name of the plant (required), installation date (required), national city (required), detailed address (optional), time zone (required), PV capacity (required), plant type (required, Household plant/ /Commercial plant/Ground plant), fund income (optional), plant picture (optional, when the user does not upload pictures, a default plant picture will be given).

b) There are three ways to fill in the plant address, map selection, automatic acquisition, and manual input.

Map selection, users can select any location on the map, then the detailed location will be filled automatically of the country.

Automatic acquisition, through satellite positioning, obtain the current location of the user, then the detailed location will be filled automatically of the country .

Manual input, the user manually inputs the country, city and detailed address.

c) This page can be skipped. After skipping, the user registration account will be logged directly, enter the APP plant page. Skipping the process of adding plant, the default plant will not be generated. When enter the APP plant page, the system will remind the user to add the plant.

4.3 Sign in and log out

09:39 * 🔔 📶 HD 📶 📶 📶 📶 📶

GROWATT Demo >>

[Forgot password](#) [Register](#)

The user can log in the APP through the existing account and password. The system automatically determines the account's attributes and distributes the server. The ShinePhone system is divided into China and Worldwide servers.

After the users log in successfully, for the next time log in, you can directly select the account number from the information the phone remembered.

If you have any questions about the password, or if you enter the wrong password, you can click the eye icon on the right side of the password input box to view the password, and click the password again to hide it.

4.4 EV Charger Internet Configuration

For new users, please click the "+" in the upper right corner of the overview, select "GroHome" and add device (EV Charger), for users who already have had "GroHome" page, go to the "GroHome" page directly and click the "+" in the upper right corner to add device (EV Charger).

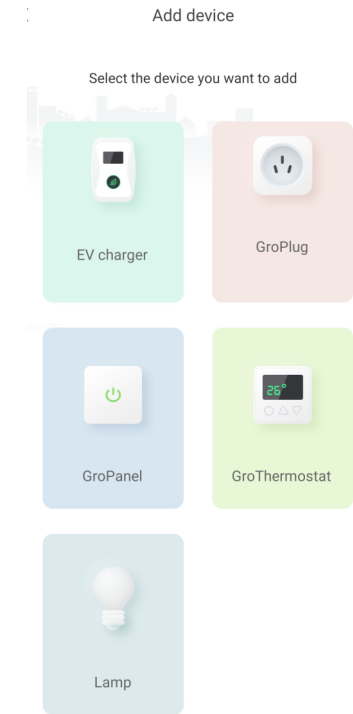
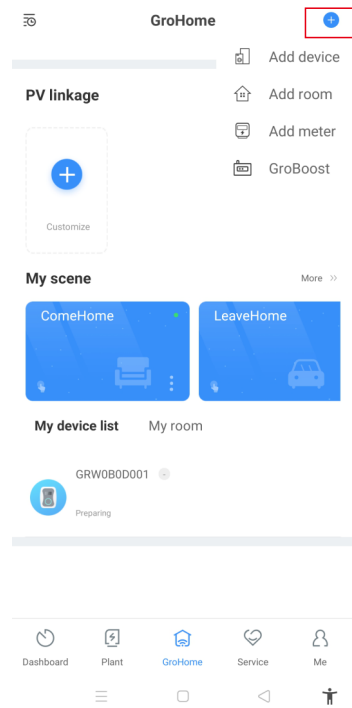
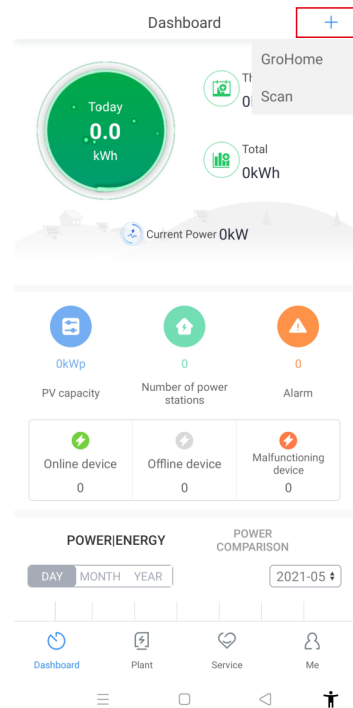

If the users haven't built the "power plant" before and click "add device", the app will remind you to add a plant firstly, and the app will allow to "add device" after finishing filling the information of the plant.

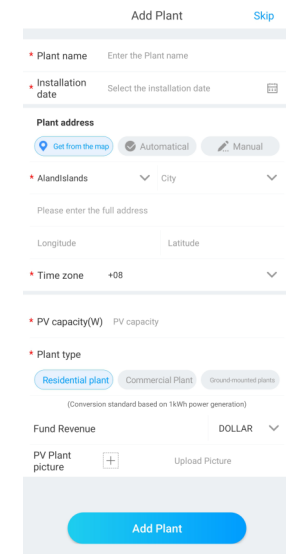
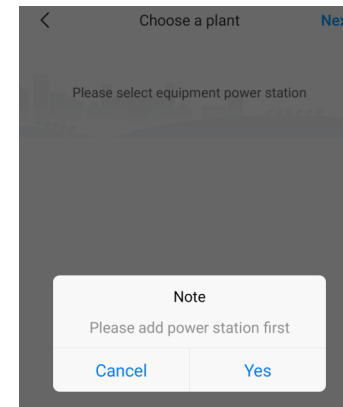

V. EV charger Internet configuration

5.1 WiFi Configuration

- a) Choose a related power plant after adding the device (Note: a power plant is required to build before adding the EV Charger).
- b) Enter the serial number of the EV charger or scan the Bar/QR code to add the EV charger
- c) Select "WiFi" for network configuration.
- d) Enable the "WLAN" in the setting and connect to the "WIFI" whose name is consistent with the serial number of the EV charger, then enter the WiFi password (default WiFi password is: 12345678) and click "next".
- e) Enter the WiFi name and password of your router (the connected WiFi is required 2.4GHz WiFi, and the network should be available), and then click "Next".
- f) Please wait 2-5 minutes and refresh the EV charger status to confirm whether the communication is successful.

Note: If the EV charger has been configured before, and don't need to configure the network again.

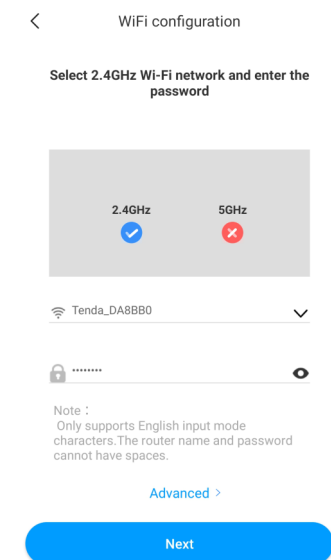
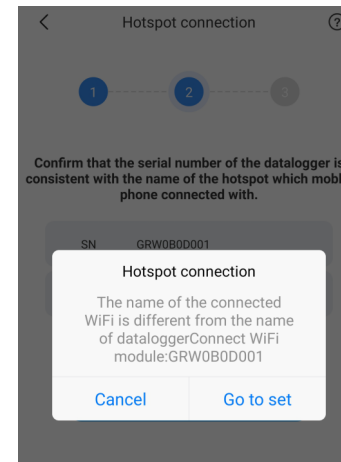
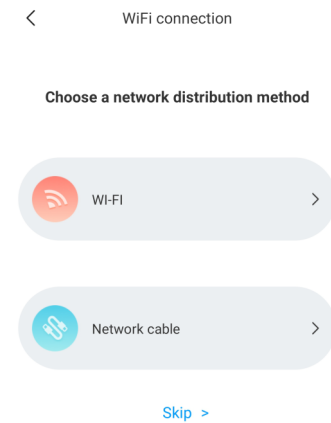
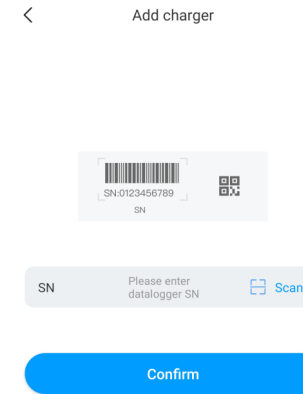
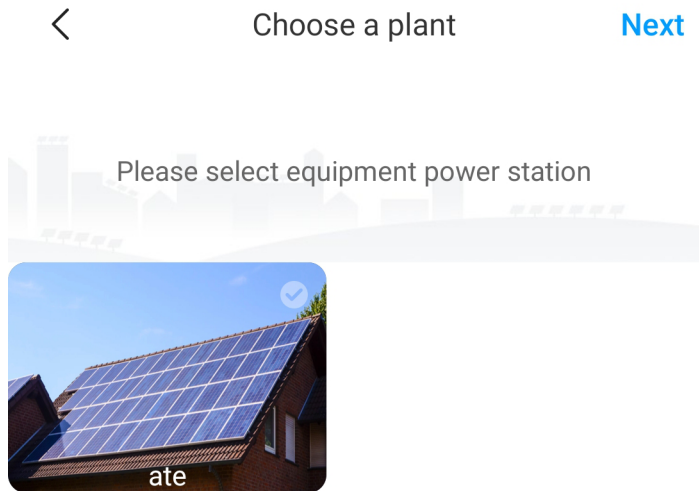

OFF

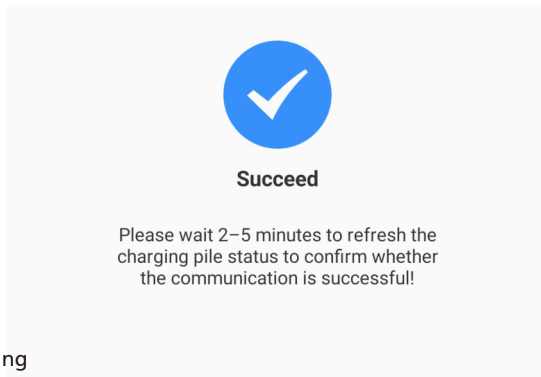

Advanced Setting

If the EV charger has an external current sensing device, then it click the “advanced” in the WiFi configuration page, it needs to choose the corresponding configuration (CT or meter type, choose the right brand of the meter type, Acrel or Eastron).

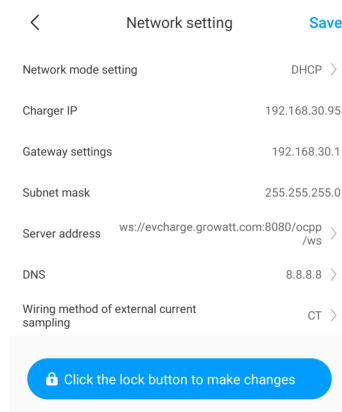
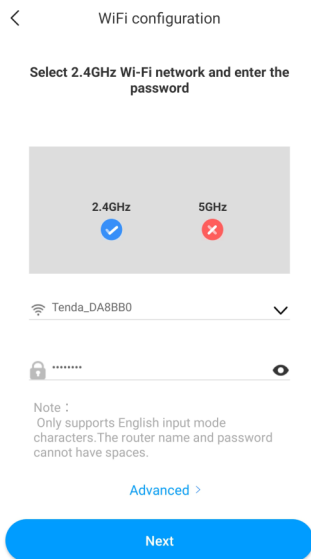
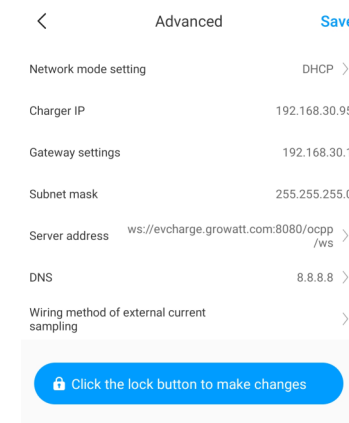

5.2 Network Cable Connection Configuration

- Choose a related power plant after adding the device (Note: a power plant is required to build before adding the EV Charger. Enter the serial number of the EV charger or scan the Bar/QR code to add the EV charger.
- Select "Network Cable" for network configuration.
- Click "cancel" and the network will be connected dynamically based on the dynamic IP mode.
- Waiting for 2-5 minutes which EV charger will refresh its status, and confirm whether the communication is successful.

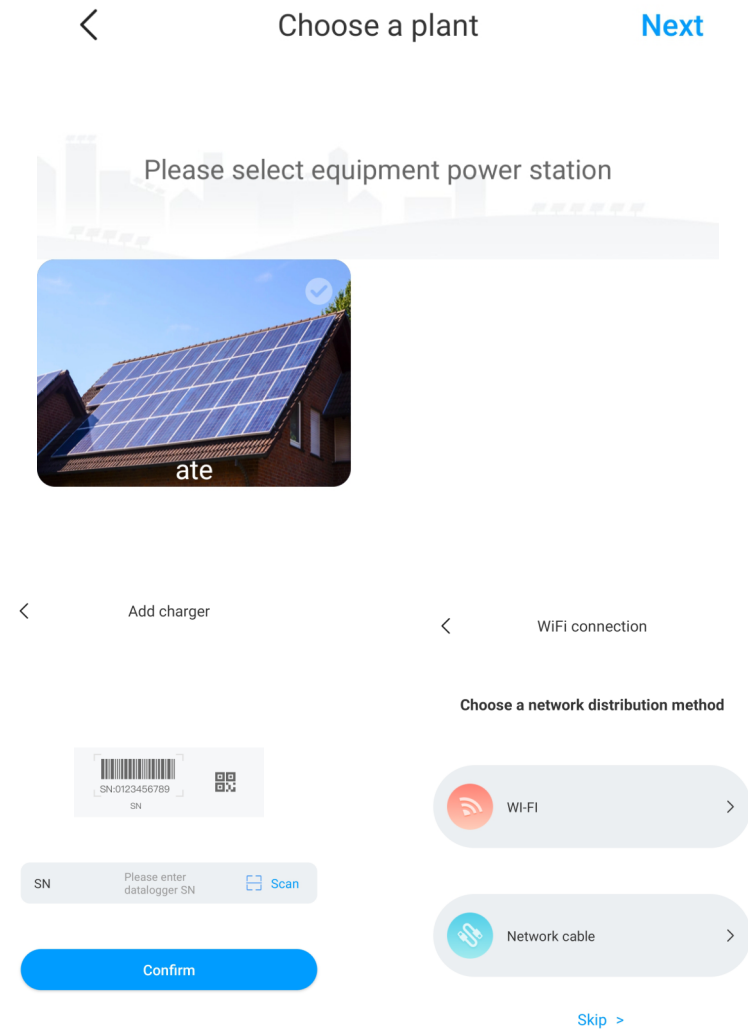
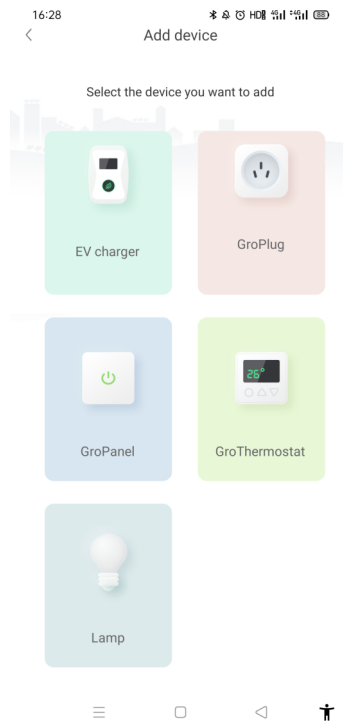

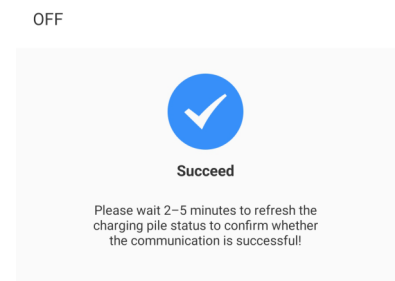
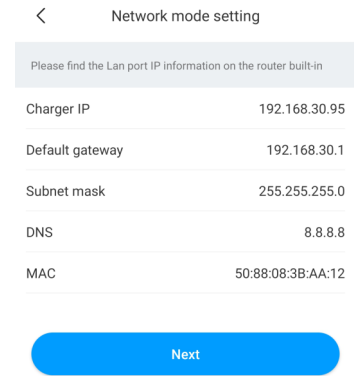
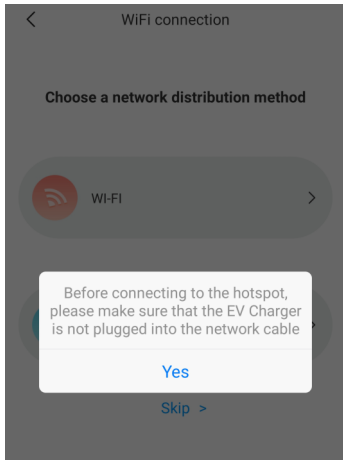

Note: If the users want to set the static IP mode

1. Click "go to set" during (d) step and make sure the network cable is disconnected
2. Do the hotspot connection, connect to the WiFi whose name is consistent with the series number of EV charger, and enter the default password:12345678.
3. Make sure the parameters of IP and getaway are the same as that of the router and click "next".
4. Connect the network cable and wait for 2-5 minutes which EV charger will refresh its status, and confirm whether the communication is successful.

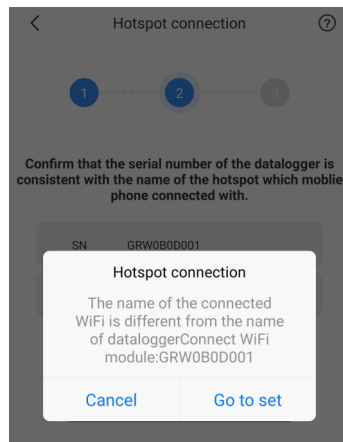
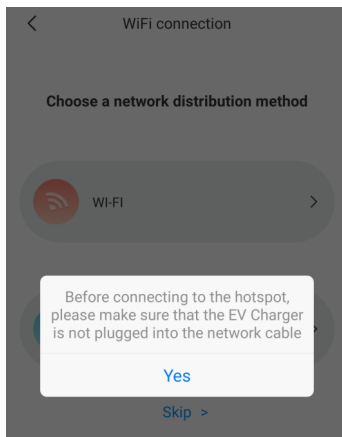

5.3 4G Configuration

If the EV charger is a 4G model, then the user can click the “skip” directly during the page of network configuration methods.

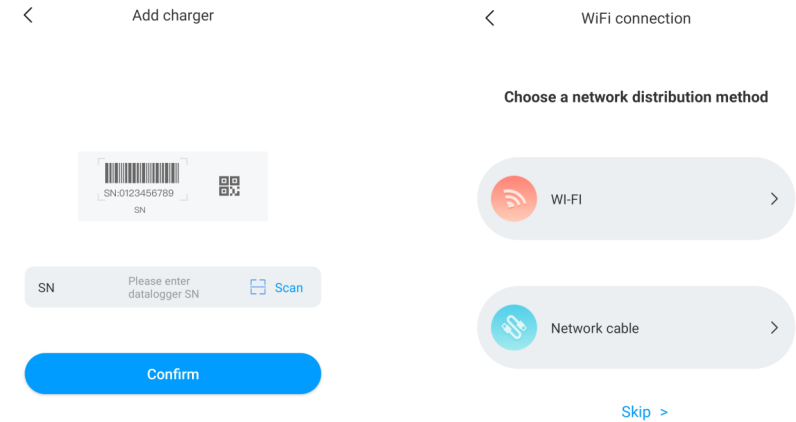
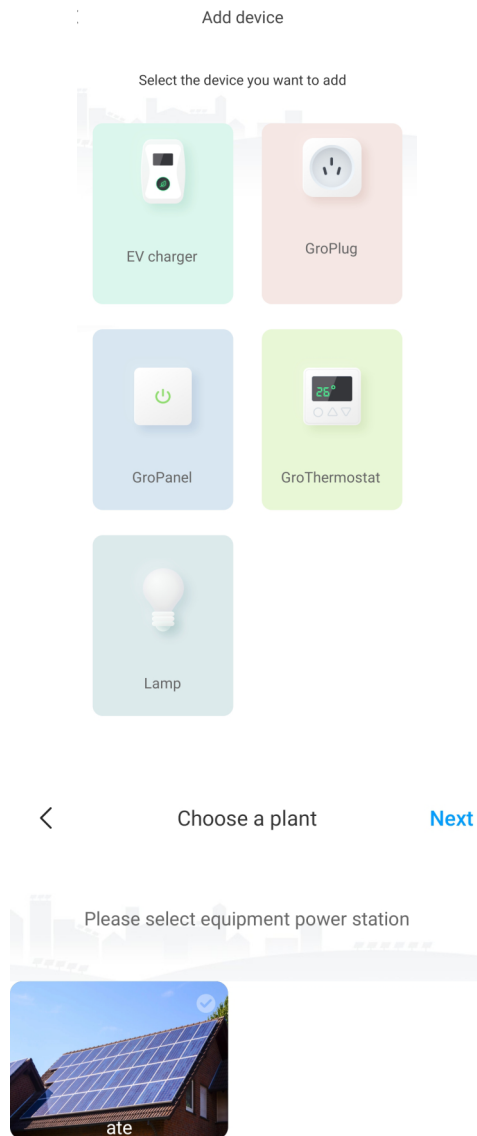

5.4 AP Mode Configuration

If the network connection is abnormal, the users can use the AP mode to reset the network or do some basic setting.

- a) Click the AP mode, and enter the hotspot connection, click “next” to switch to other pairing mode.
- b) Connect the WiFi whose name is consistent with the series number of the EV charger and click next.
- c) User can check the basic information, and do some basic parameters setting like network setting, sever setting and EV charger setting.
- d) After that, waiting for 2-5 minutes which the EV charger will refresh its status.

VI. Operation instruction and LCD description

6.1 Charging mode and Operation

User can go to the "setting" page and click the "EV charger setting", users can set the charging activation way like APP, RFID, plug and charge.

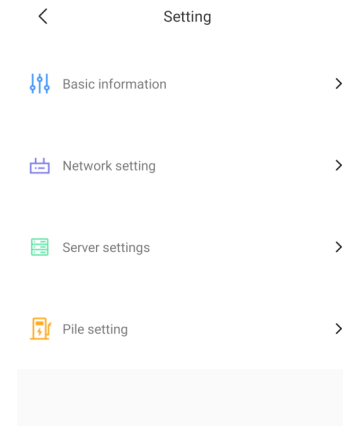
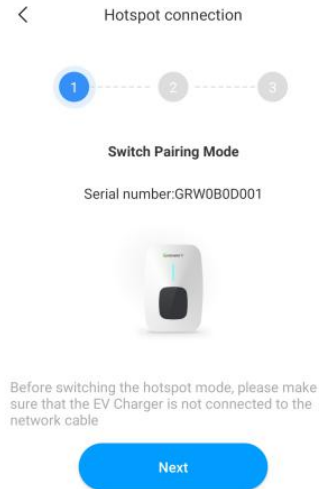
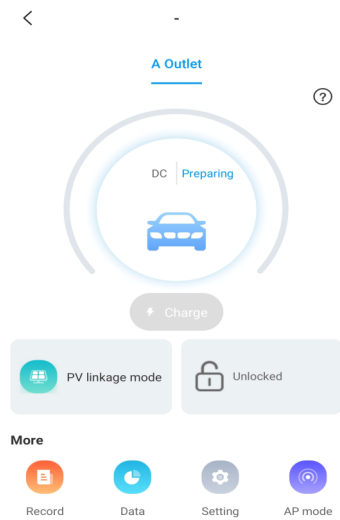

Setting	Value
Charging model	APP >
Charging rates	3.0 >
Maximum output current of electric pile (A)	32 >
Protection temperature (°C)	80 >
External monitoring maximum input power (KW)	45 >
Allow charging time	02:00-23:00 >
Wiring method of external current sampling	CT >
Meter device address	2 >
Meter type	Eastron >
Electronic lock configuration	Automatic >

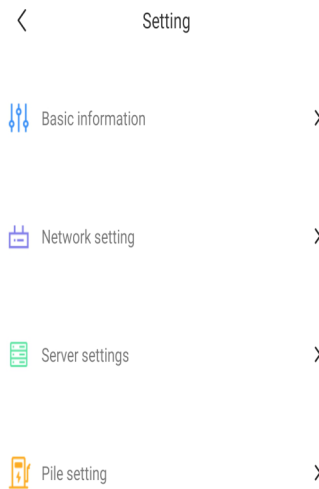
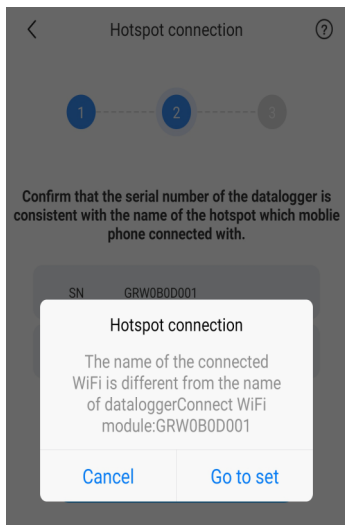

APP/RFID mode:

Initiate or cease charging by using APP or by swiping RFID card. You can also use APP for reservations and choose the work mode you need.



5.2 LCD interface introduction

RFID mode:

Charging can only be initiated or ceased by swiping RFID card.

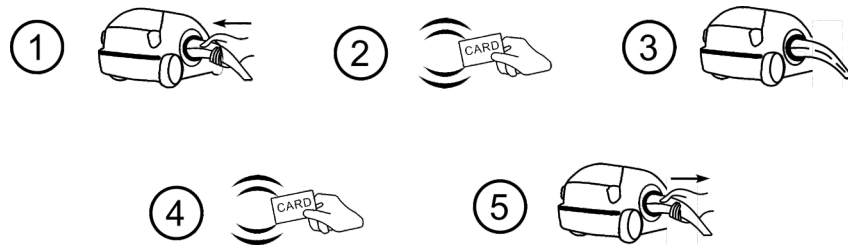

RFID mode operation process flow

Plug&Charge:

Charging will start automatically after EV plugged in. If you want to stop the charging, just press the forced on/off button on the side of the charger.

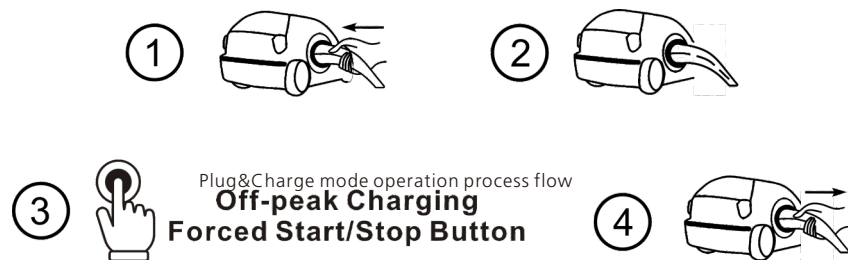

Plug&Charge mode operation process flow
Off-peak Charging
Forced Start/Stop Button

	<p>Interface of standby status. Charging mode is displayed at the bottom centre of the screen.</p>
	<p>Interface of user card information Displayed for user to check card ID and balance when swiping RFID card while EV is not connected</p>
	<p>Interface of charging status. Displayed when the charging is being carried out. There is charging time, consumed electricity, charging cost on it, as well as real-time charging voltage and charging current.</p>
	<p>Interface of charging complete. Displayed when the EV stops charging, or forced on/off button is pressed on charger side.</p>

VII. EV Charger Work Modes

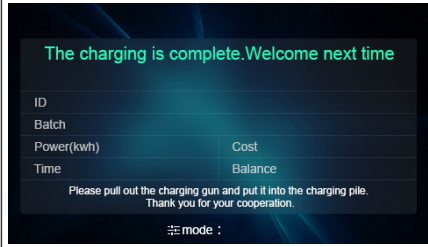
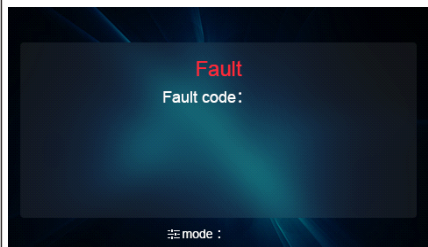
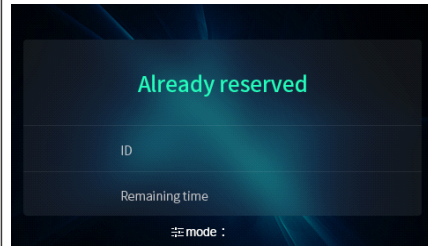
	<p>Interface of billing. After scanning QR code or swiping RFID card for billing, this interface will open up to display user ID/charging time/cost/balance, etc. This interface will also come out when you stop charging on the Growatt APP or when you press the forced on/off button or unplug the gun at Plug&Charge mode.</p>
	<p>Interface of fault status. Displayed with fault code and fault description when fault occurs.</p>
	<p>Interface of reserved status. If the back-office server and APP support reservation function and the charger is reserved, this interface will come out showing user ID and remaining time to reserved time.</p>

7.1 Fast Mode

Plug&Charge:

Click “charge” directly and the EV will be charged at maximum power coming from a renewable energy source or simply from the grid, especially quickly if you’re in a hurry, and support multiple control strategies of timer, charging capacity, charging budget.

Note: the reservation function only can be set when the EV charger is in idle status.

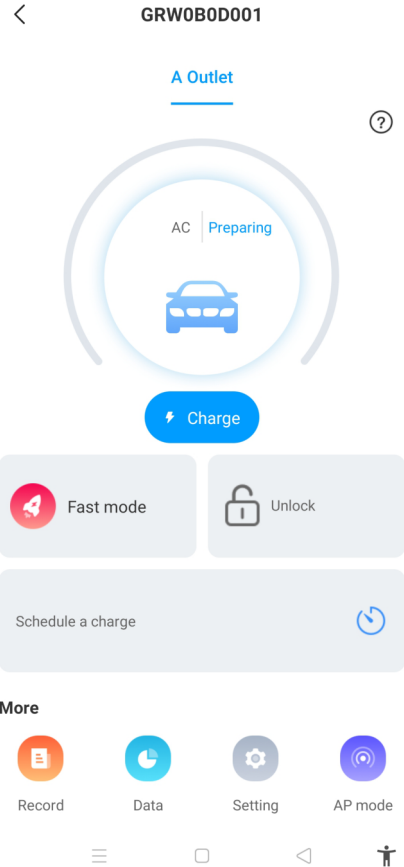

Time Reservation

It can be divided into charging time and charging period reservation, users can set when it will start to charge and how long the charging will continue, also can enable “every day” to make it work following that strategy to work all the time.

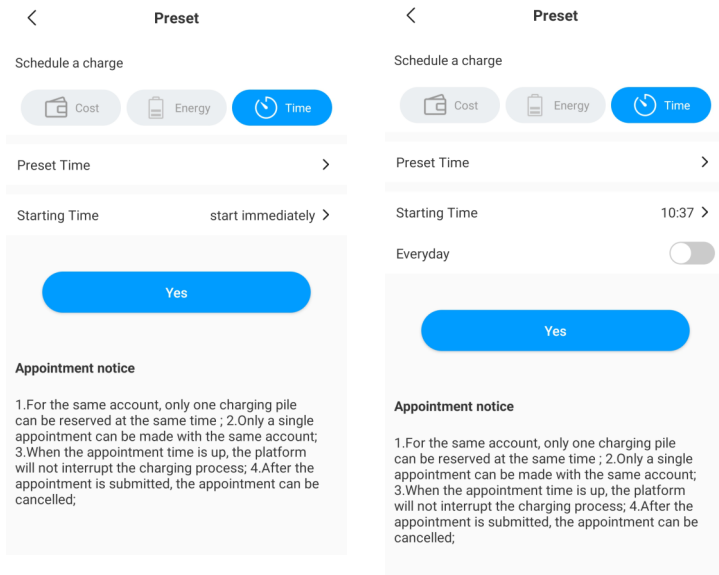

Charging Capacity Reservation

Users can set the target charging capacity(kWh) and the start time through clicking “energy”, and also can enable “every day” to make it to work following that strategy to work all the time.

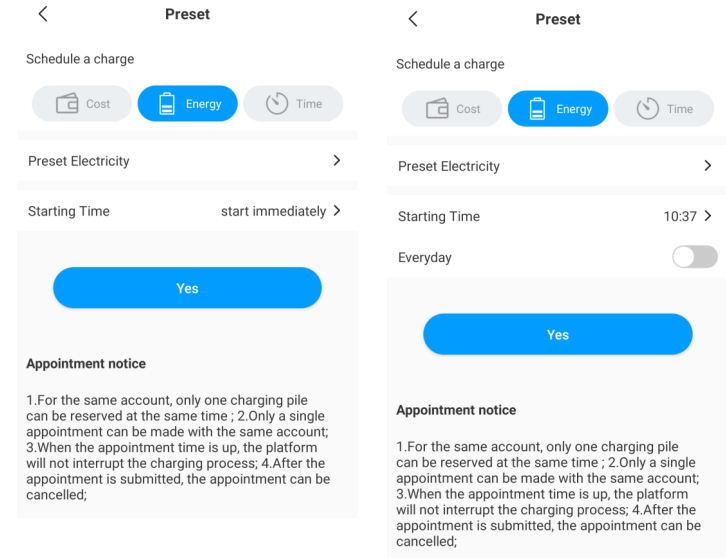

Charging Budget Reservation

Users can set the target charging budget and the start time through clicking the “cost”, and also can enable “every day” to make it to work following that strategy to work all the time.

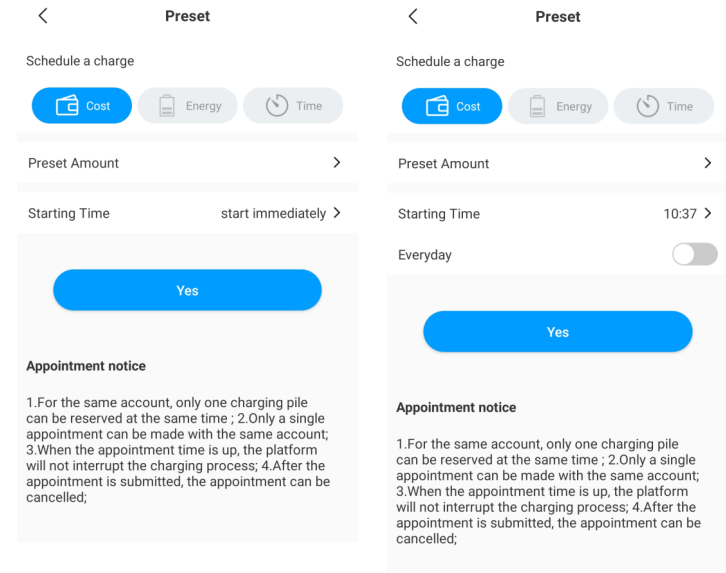

7.2 PV Linkage Mode

Introduction

Driven by solar, charge your car with renewable energy, the EV will be charged by the surplus solar power dynamically, combining PV and EV charger together to maximize the solar self-consumption rate and cut your bill.

Note: The EV should connect with the EV charger, and the PV Linkage mode will be automatically activated when the solar power is sufficient.

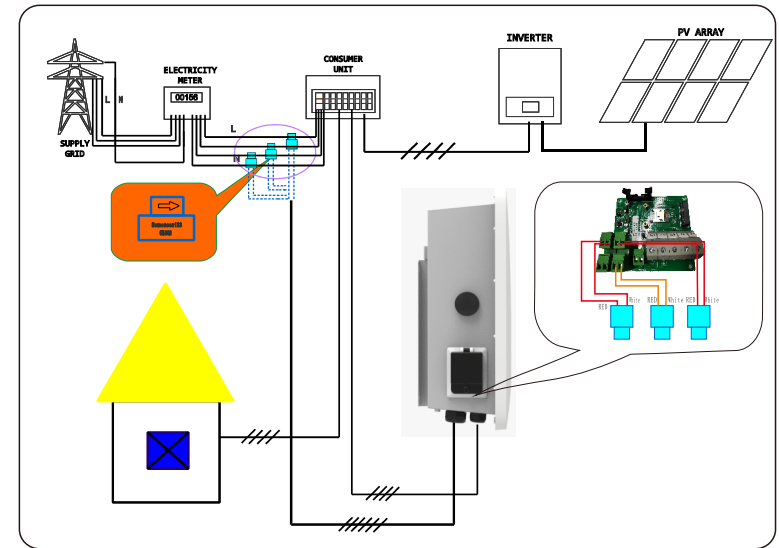
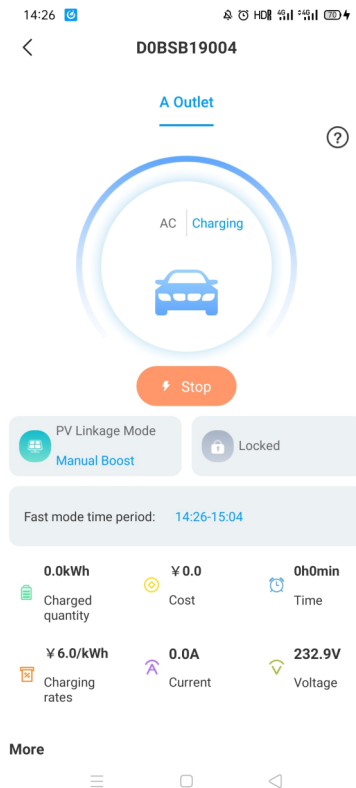

8.3 If meter is used, please wire it as below

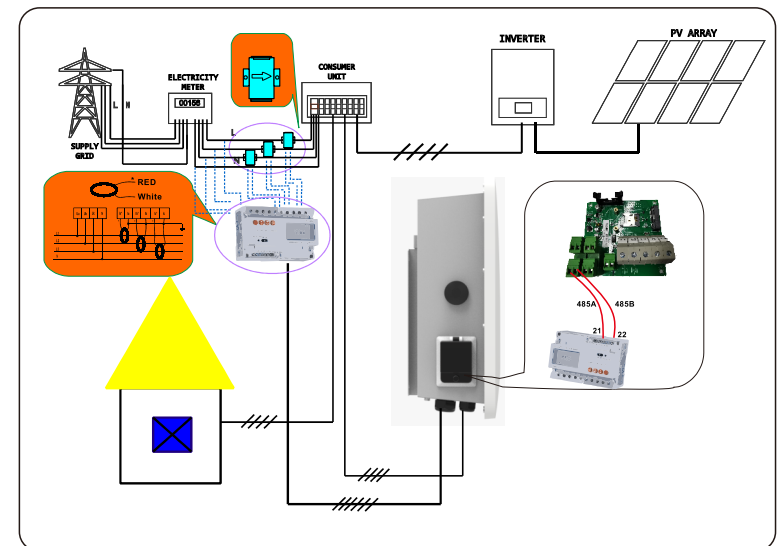

Wiring

To monitor the real-time power import and export, a CT or meter is needed for this function to work properly.

If CT is used, the wiring will be as below,

APP Operation

The PV linkage mode require the EV charger to connect with an external current sensing device, and choose the corresponding configuration (CT or meter type, choose the right brand of the meter type, Acrel or Eastron).

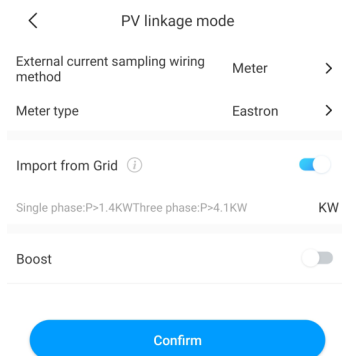

Function of importing from the grid

- Disable the function of importing power from the grid.

The EV will be charged dynamically only by surplus solar power when the surplus solar power is greater than Min. operation power*, When surplus solar power is lower than Min. operation power, then the EV charger will stop charging .

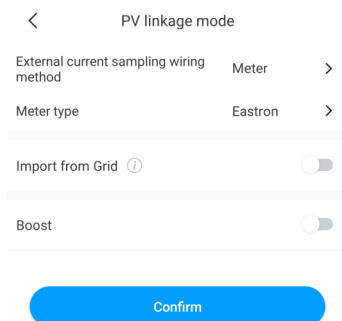

- Enable the function of importing power from the grid set the max. importing value

The EV will be charged dynamically only by surplus solar power when the surplus solar power is greater than *Min. operation power, when surplus solar power is lower than *Min. operation power, the EV charger will use grid power to offset the shortage part and keep charging at Min. operation power.

Note: *Min. operation power: 1.4kW for three-phase EV charger, and 4.1kW for three-phase EV Charger.

Boost Function

- Manual Boost Function

It is useful if users arrive home with an almost empty battery and users want to charge the EV quickly to ensure enough energy for a short trip when the solar energy is insufficient

While users enable the manual boost function and set "start time" and "end time", the EV charger will charge the EV at its max. power during a set period even drawing the power from the grid, after that, it will recover back to the normal PV linkage mode.

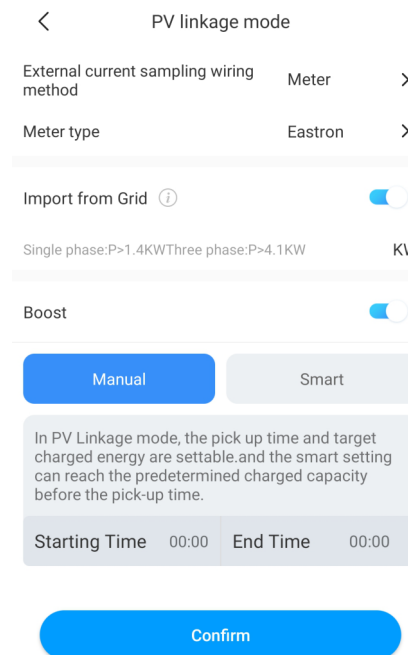

● Smart Boost Function

It's useful to guarantee EV's battery capacity before a set time when the solar energy is insufficient.

While users enable the smart boost function and set "Pick-up time" and "Preset electricity", the EV charger will charge the EV with a target kWh figured by a set time, it may draw the power from the grid to guarantee the EV's battery capacity when the solar energy is insufficient.

Example: if the users enable smart boost and set the "pick-up time" is 22:00, and "preset electricity" is 20kWh. In sunlight hours, the EV has been charged by surplus solar energy with the only 10kWh of charge accumulated, because users activated the smart boost, then the THOR EV Charger will automatically boost the charge to the required 20kWh by 22:00 even taking power from the grid.

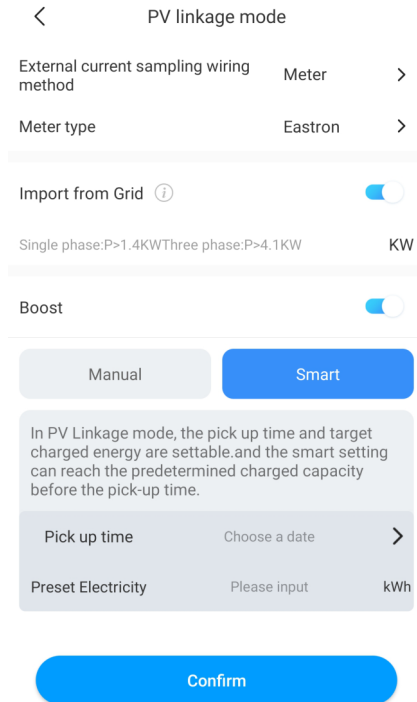

7.3 Off-peak modes

Introduction

Once enable the Off-Peak mode, the EV charger will automatically charge the EV when it's at off-peak time to reduce the electricity bill. Users also can customize their low-rate charging time in the off-peak mode page.

Note:

1. Users need to input the charging rates in the setting page manually before enabling off-peak modes.
2. The EV should connect with the EV charger, and the off-peak mode will be automatically activated at the low-rate charging time.

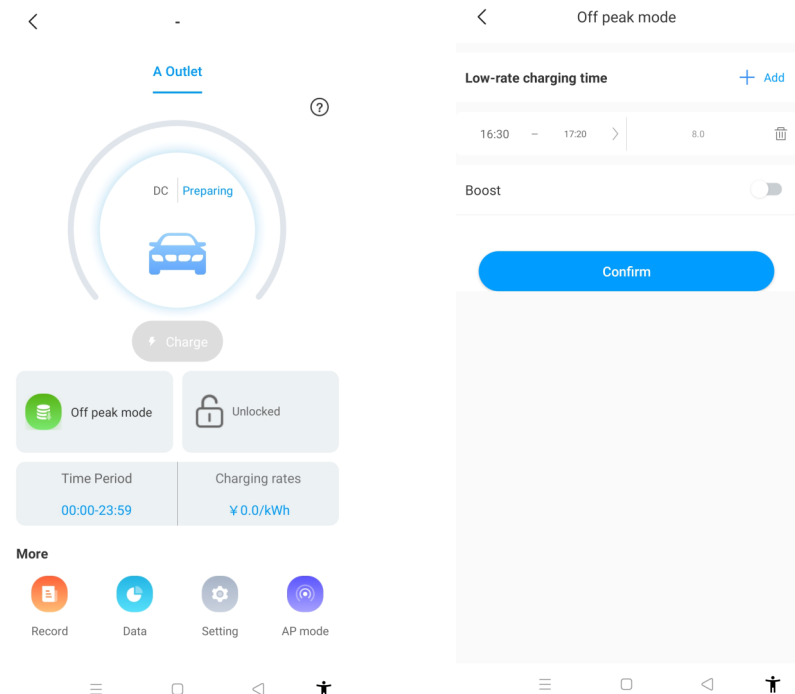

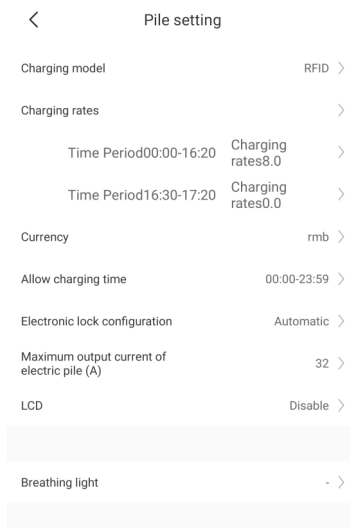

● Smart Boost Function

It's useful to guarantee EV's battery capacity before a set time when the off-peak time is not long enough.

While users enable the smart boost function and set "pick-up time" and "preset electricity", the EV charger will charge the EV with a target kWh figured by a set time, it may draw the power from the grid to guarantee the EV's battery capacity when the off-peak time is not long enough.

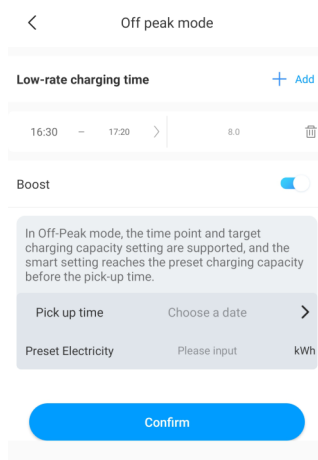

7.4 Load balancing function

The EV charger can read the incoming power to the house with an additional CT/Meter. Then the EV charger will adjust its charging power dynamically according to the home power to avoid exceeding the limited point, always charge your car at the maximum charging speed without trigger the power limitation.

Note: The load balancing function requires an external CT/Meter, and please follow the wiring method of PV linkage mode.

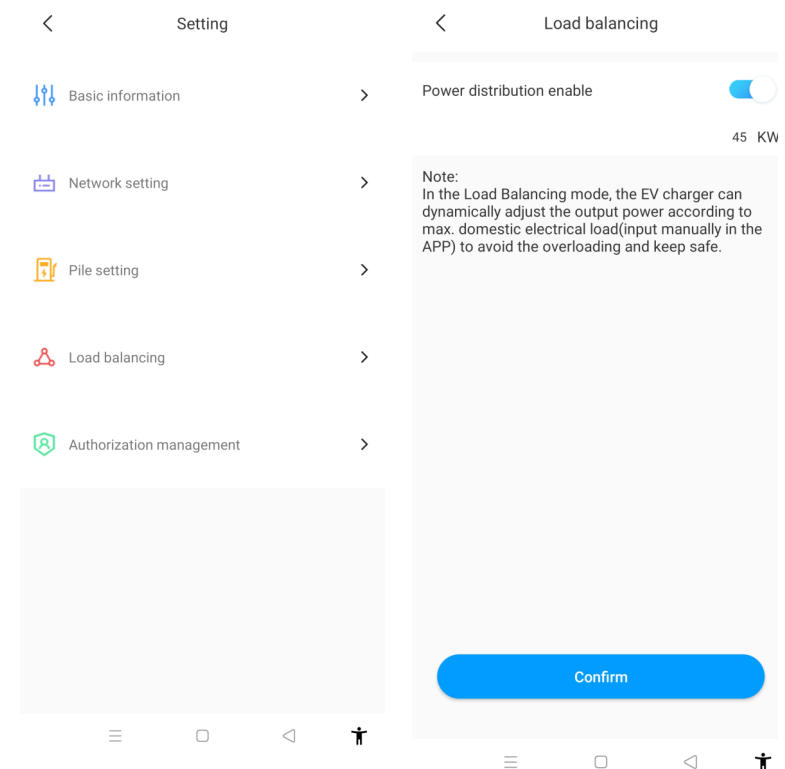

VIII. Other Settings

The setting page includes basic information, network setting, pile setting, load balancing and authorization management.

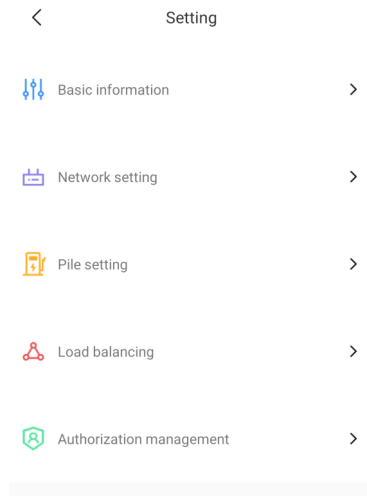

- **Basic information:** EV charger ID, EV charger name, country and city, version number.

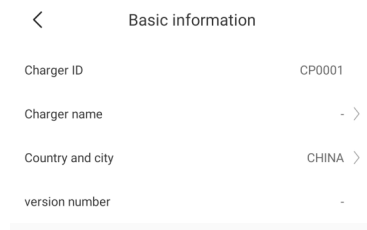

- **Network setting:** network connection method, network mode setting, gateway settings, subnet mask, DNS address.

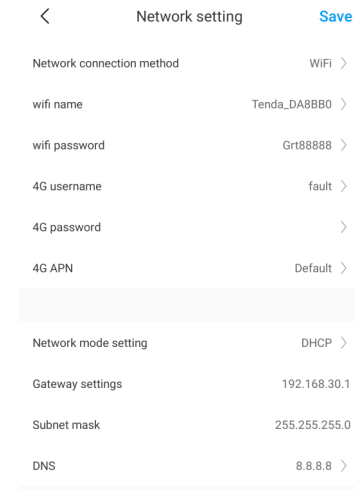

● EV charger setting:

- 1) Charging rates: users can set their charging fees, which could be used for the calculation of electricity cost and off-peak mode.
- 2) Allow charging time: user can use it to limit the time to use the EV charger.
- 3) Maximum output current of the EV charger: users can use it to limit the max. power output from the EV charger.
- 4) Breathing light: the brightness of the breathing light is adjustable.

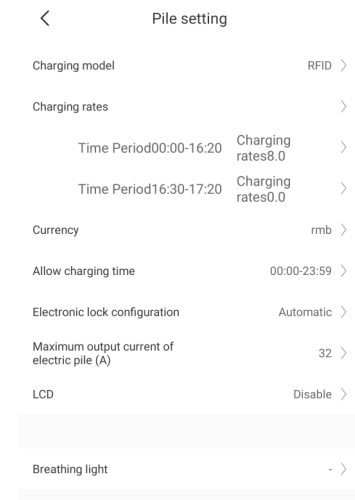

Permissions: it's useful for authorization management, add and authorize the other account which can use the EV Charger directly.

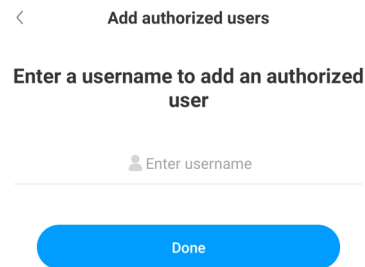
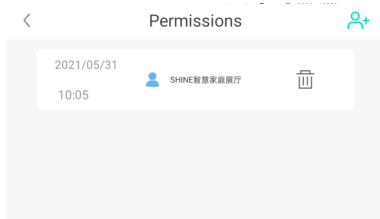

IX. Record

a) Charging record:

Display the serial number of the EV charger, number of the charging gun, start time, end time, charging time, charging cost, charging capacity, and self-consumption rate.

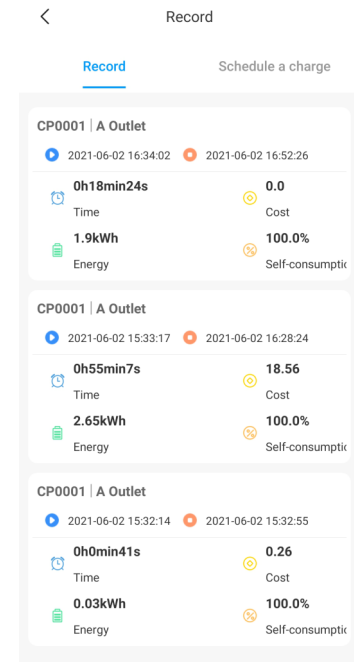

b) Schedule record:

Display the list of charging schedules that have been set before.

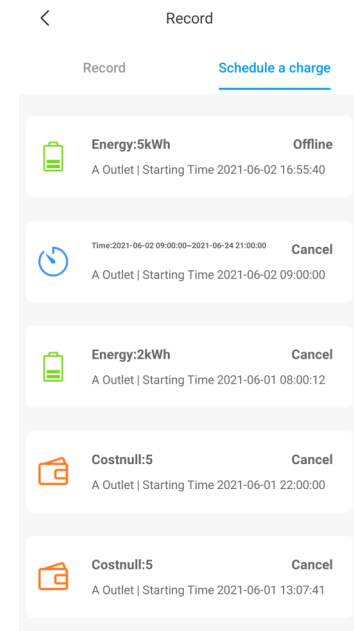

X. Data

The users can read the total charge capacity(kWh) and cost, also the self-consumption energy and rate by day, month, and year.

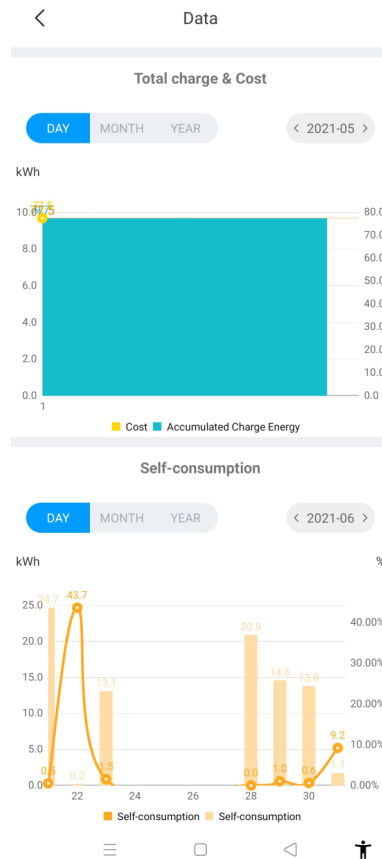

XI. Troubleshooting

11.1 Troubleshoot by LED behavior or LCD display

If fault occurs, users can check the fault information on the LCD or by the number of blinks of the LED indicator light. Each fault is indicated with a sequence of different numbers of LCD blinking. A pause of 3 seconds between each sequence indicates the beginning or end of a sequence. If multiple faults happen at the same time, each sequence of blinking shows in chronological order at an interval of 3 seconds. Please contact with our service engineer if the fault occurs.

Please see the table below for detail information

No.	Fault code on LCD (if available)	Number of blinks of the LED	Fault description
1	100	3	The red emergency stop button is pressed or broken
2	101	1	Over voltage on phase L3
3	102	2	Under voltage on phase L3
4	103	1	Over voltage on phase L2
5	104	2	Under voltage on phase L2
6	105	1	Over voltage on phase L1
7	106	2	Under voltage on phase L1
8	107	2	Under voltage on all three-phases
9	108	4	Over current
10	109	5	Over temperature
11	110	6	DC leakage current detected
12	111	7	RS485 communication fault
13	112		Reserved
14	113	9	Type A switch fault
15	114	10	Relay fault
16	115	11	PE fault
17	116	12	PEN fault
18	117		Reserved
19	1000		Other faults

XII. Specification

Model	Growatt THOR 11AS-S/P Growatt THOR 22AS-S/P
Dimension (mm)	295/466/189(W*H*D)
Weight (kg)	<16
Display	LCD
Casing Material	Stainless steel& Engineering plastics& Tempered glass
Input	
Voltage	AC 400V
Frequency	50 Hz
Output	
Voltage	AC 400V
Max current	16/32A
IP Protection degree	IP65
Working environment temperature	-20℃ ~ +50℃
Relative humidity	5% ~ 95%
Altitude	<2000m
Communication	Ethernet/WIFI/4G
Payment	RFID/APP
Standby power	<8W
Standard	IEC-62196-2;EN61851
Mounting	Wall/Pole
Certificate	CE
Protection features	
Over voltage	450V
Under voltage	329V
Over current	20A/40A
Short circuit	Yes
Leakage protection	Yes

XIII. Annex

13.1 Electrical diagram

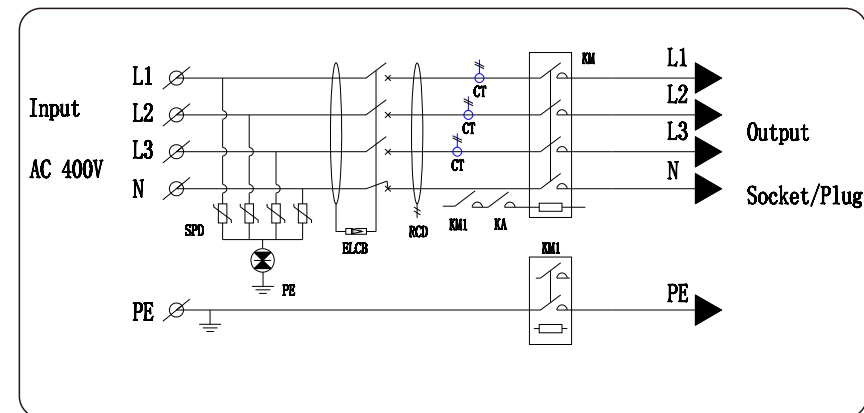

Fig11-1. Main circuit diagram

13.2 Contact

Growatt New Energy Co.,Ltd

4-13/F, Building A, Sino-German (Europe) Industrial Park,
Hangcheng Ave, Bao'an District, Shenzhen, China

Website:www.ginverter.com

Service hotline:+ 86-755-27471942

E-mail: service@ginverter.com