

Download  
Manual

## ARK High Voltage Battery System

### User Manual (V1.0)

**Shenzhen Growatt New Energy Co., Ltd**  
4-13/F, Building A, Sino-German(Europe) Industrial Park,  
Hangcheng Ave, Bao'an District, Shenzhen, China

**T** +86 755 2747 1942

**E** service@ginverter.com

**W** www.ginverter.com

GR-UM-223-A-00

# Contents

## About this Document

This document describes the installation, electrical connection, operation, commission, maintenance and troubleshooting of ARK High Voltage Battery System. Before installing and operating ARK High Voltage Battery System, ensure that you are familiar with product features, functions, and safety precautions provided in this document.

Symbol	Description
 WARNING	Indicates a potentially hazardous situation, if not avoided, could result in serious injury or death.

## 1 Product Overview

- 1.1 Intended Use
- 1.2 Appearance
- 1.3 Working Principle and Function

## 2 Safety

- 2.1 Basic security
- 2.2 Safety Precautions
- 2.3 Warning Labels
- 2.4 Emergency Responses

## 3 Storage and Transportation

- 3.1 Storage Requirements
- 3.2 Transportation Requirement

## 4 Installation

- 4.1 Basic Installation Requirements
- 4.2 Installation Required Tools
- 4.3 Installation Procedures
- 4.4 Electrical Connection

## 5 Power on/off Battery system

- 5.1 Power on Battery system
- 5.2 Power off battery system

## 6 Maintenance Guide

- 6.1 Preparation
- 6.2 Battery pack or high voltage controller replacement
- 6.3 System fault information and suggestions

## 7 Technical Specifications

- 7.1 System Data
- 7.2 Battery System designation
- 7.3 HVC 60050-A1
- 7.4 ARK 2.5H-A1

## Appendix I

## Appendix II

# 1 Product Overview

## 1.1 Intended Use

The entire ARK High Voltage Battery System includes a HVC 60050-A1 (high voltage controller) and multiple ARK 2.5H-A1 (battery pack).

Each ARK 2.5H-A1 consists of 50Ah cells which form 51.2V voltage battery pack via one parallel and sixteen serial connection (1P16S). Two to ten ARK 2.5H-A1 can be connected in serial to extend the capacity and power of energy storage system.

The ARK battery system powers the loads through PCS at nighttime without solar; when solar becomes available during daytime, solar energy powers the loads as a priority and store residual solar power into the ARK battery system.

## 1.2 Appearance

### 1.2.1 HVC 60050-A1 (high voltage controller)

The high voltage controller is composed of battery control unit, DC breaker, power supply and communication terminals. The appearance of the product is shown as below.

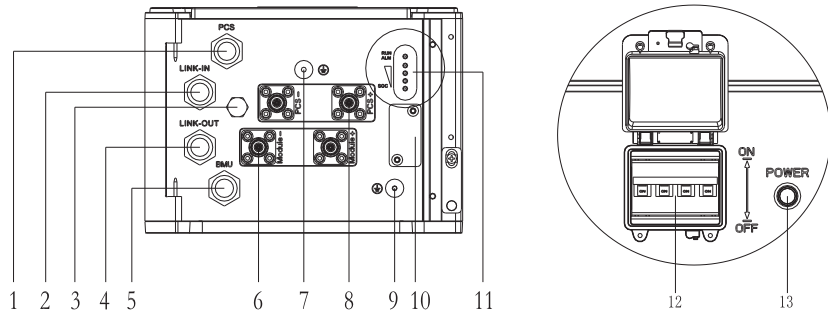

Fig 1.1: Schematic diagram of power panel

Location	Port	Function
1	PCS	Communication with PCS
2	Link-In	Battery system parallel communication entrance
3	Pressure relief valve	Pressures inside is released via the vent
4	Link-Out	Battery system parallel communication export
5	BMU	Communication with battery module
6	Module+ / Module-	Connect to the power terminal of the battery string
7	⊕	Ground terminal
8	PCS+ / PCS-	The output from battery system to the PCS
9	⊕	Ground terminal
10	USB interface	USB communication interface
11	LED	SOC and working status indication of the system
12	Breaker	Breaker to turn on/off the whole battery system
13	Power button	Wake up the battery system

Dimension (unit: mm)

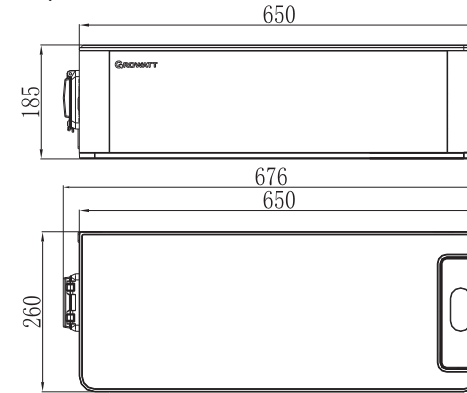

Fig 1.2: Dimension of HVC 60050-A1

### 1.2.2 ARK 2.5H-A1 (battery pack)

ARK 2.5H-A1 consists of battery module (including cell and mechanical parts), Battery management unit (BMU) as well as power and communication terminals. Product appearance is shown as below.

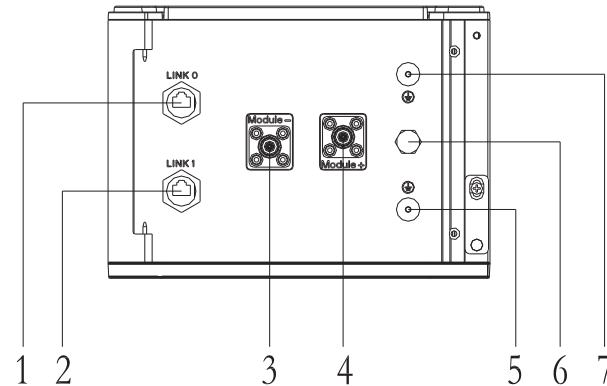

Fig 1.3: Schematic diagram of power panel

Location	Port	Function
1	Link0	Communicate with the previous module Link1
2	Link1	Communicate with the next module Link0
3	Module-	Connect to the positive terminal of the adjacent module
4	Module+	Connect to the negative terminal of the adjacent module
5	⊕	Ground terminal
6	Pressure relief valve	Pressures inside is released via the vent
7	⊕	Ground terminal

Dimension (unit: mm)

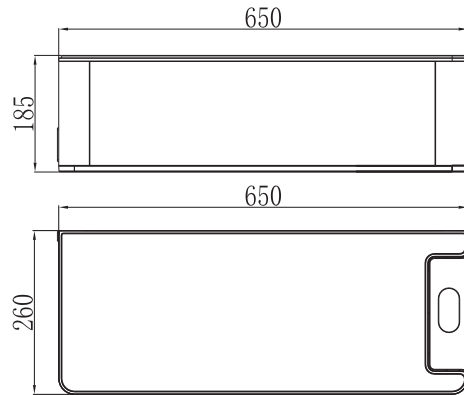

Fig 1.4: Dimension of ARK 2.5H-A1

## 1.3 Working Principle and Function

The ARK high voltage battery system is composed of a high voltage controller HVC 60050-A1 and battery pack ARK 2.5H-A1 in series. It contains electrochemical batteries, battery control units, battery management units, power and signal terminals, and mechanical parts.

Compared with other battery systems, it has better charging and discharging performance, higher charging and discharging efficiency, more accurate status monitor, longer cycle life and less self-discharge loss.

A single cluster system can connect 2 to 10 packs in series to increase the capacity and power of the battery system. The entire battery system communicates with the inverter through CAN communication, and the operation stability is high.

- Monitoring: voltage, current and temperature detection of both single cells and battery system.
- Protection and Alarm: protection and alarm when overvoltage, under voltage, over current, over temperature or under temperature occurs. See Appendix I for the details.
- Report: report all alarm and status data to PCS.
- Series connection: support two to ten packs in Series connection.
- Power failure triggered by fault: 10 minutes after the battery system and PCS communication is disconnected or 15 minutes after undervoltage protection.

When installing or using a battery system, the safety information contained in this section must always be followed. For safety reasons, it is the installer's responsibility to be familiar with this manual and all warnings before installation.

## 2.1 Basic security

The battery system has been designed and tested in accordance with strict rules with international safety certification requirements. Before any installation or use of the battery system, please read all safety instructions carefully and always follow the relevant rules. Growatt is not responsible for any consequences resulting from violation of the following regulations:

- Damage occurred during transportation.
- Incorrect transportation, storage, installation and use, or customer fails to convey the correct information about transportation, storage, installation and use to terminal customers.
- Non-professional installation.
- Failure to obey the rules of this operation instructions and safety precautions in this document.
- Unauthorized modifications or removal of the software package.
- The product's tamper label is damaged or the product lacks any parts (except authorized disassembly parts).
- Operation in extreme environments which are not allowed in this document .
- Repair, disassemble, or change packs without authorization and cause failure.
- Damage to shell labels or modifies date of production.
- Packs fail to be charge for more than six months.
- Damages due to force majeure (such as lightning, earthquakes, fire, and storms).
- Warranty expiration.

## 2.2 Safety Precautions











### 2.2.1 Environment requirements

- Do not expose the battery to temperature above 50°C or heat sources.
- Do not install or use the battery in wet locations, moisture, corrosive gases or liquids, such as bathroom.
- Do not expose the battery to direct sunlight for extended periods of time.
- Place battery in safe place away from children and animals.
- Battery power terminals shall not touch conductive objects such as wires.
- Do not dispose the batteries in fire, which may cause an explosion.
- The battery system shall not come in contact with liquids.

### 2.2.2 Operation Precautions

- Do not touch the battery system with wet hands.
- Do not disassemble the battery system without permission.
- Do not crush, drop or pierce the battery pack and high voltage controller.
- Dispose the batteries according to local safety regulations.
- Store and recharge battery in accordance with this manual.
- Ensure the connection of ground wire reliable.
- Remove all metal objects such as watches and rings that could cause a short-circuit before installation, replacement and maintenance.
- The pack shall be repaired, replaced or maintained by skilled personal that has been recognized.
- When storing or handling batteries ,do not stack batteries without package.
- Do not broke the battery, the released electrolyte may be toxic and is harmful to skin and eyes.
- Packaged batteries should not be stacked more than specified number stipulated on the packing case.
- Do not use damaged, failed or deformed batteries, which may lead to high temperature or even dangerous accidents. Continued operation of damaged battery may result in electrical shock, fire or even worse.

### 2.3 Warning Labels

Symbols	Description
	Do not dispose in trash
	Lithium ion battery can be recycled
	Certification in European union area
	Electric shock hazard
	Explosive gas
	May leak corrosive electrolyte
	Heavy enough to cause severe injury
	Keep the Pack away from children
	Make sure the battery polarity well connected
	Do not expose to fire
	Operate as the Manual











  Lithium Ion Battery	
Model	ARK 2.5H-A1
Nominal Voltage	51.2V
Nominal/Rated Capacity	50Ah/45Ah
Nominal/Rated Energy	2560Wh/2300Wh
Rated Current	25A
Ingress Protection	IP 65
Operating Ambient Temperature	-10°C ~ +50°C
    Made In China	

Fig 2.1: Nameplate

### ! WARNING

- Do not disassemble or alter the PACK to avoid heat, explosion or fire.
- Do not use the PACK beyond specific conditions. It might cause heat generation, damage, or deterioration of its performance.
- Do not throw, drop, hit, drive a nail in, stamp on the PACK. It may cause heat generation, explosion, or fire.
- In case of electrolyte leakage, keep leaked electrolyte away from contact with eyes or skin. Immediately clean with water and seek help from a doctor.
- Do not put the PACK into a fire. Do not use it or leave it on a place near fire, heaters, or high temperature sources. It may cause over temperature, explosion or fire.
- Do not submerge the PACK in water, or wet the product. It may cause heat generation, explosion, or fire.
- Do not reversely connect the PACK positive(+)and negative(-)terminal.
- Do not short circuit by letting the PACK terminals(+and -)contact a wire or any metal.
- The unit is heavy enough to cause severe injury.
- Keep out of reach of children or animals.









Fig 2.2: Label







 ARK High Voltage Battery System	
System Model/ Nominal Voltage/ Nominal Energy/ Rated Energy	<input type="checkbox"/> ARK 5.1H-A1/102.4V/ 5.12kWh/4.6kWh
	<input type="checkbox"/> ARK 7.6H-A1/153.6V/ 7.68kWh/6.9kWh
	<input type="checkbox"/> ARK 10.2H-A1/204.8V/ 10.24kWh/9.2kWh
	<input type="checkbox"/> ARK 12.8H-A1/256.0V/ 12.80kWh/11.5kWh
	<input type="checkbox"/> ARK 15.3H-A1/307.2V/ 15.36kWh/13.8kWh
	<input type="checkbox"/> ARK 17.9H-A1/358.4V/ 17.92kWh/16.1kWh
	<input type="checkbox"/> ARK 20.4H-A1/409.6V/ 20.48kWh/18.4kWh
	<input type="checkbox"/> ARK 23.0H-A1/460.8V/ 23.04kWh/20.7kWh
	<input type="checkbox"/> ARK 25.6H-A1/512.0V/ 25.6kWh/23.04kWh
	High Voltage Controller Model
Protective Class	I
Rated Current	25A
Nominal/Rated Capacity	50Ah/45Ah
Ingress Protection	IP65
Operating Ambient Temperature	-10°C ~ +50°C
    Made In China	

Fig 2.3: Nameplate



**Notice**

The performance will be limited when the temperature is below 0°C.

# Storage and Transportation 3

## 2.4 Emergency Responses

Manufacturer takes foreseeable risk scenarios into consideration and is designed to reduce hazards and dangers. However, if the following situation occurs, do as below:

Situation Occurs	Description and action need
Leakage	Avoid touch of leaking liquid or gas. If you touch the leaking electrolyte, do as below immediately. Inhalation: Evacuate the contaminated area, and seek medical help. Eye contact: Rinse eyes with flowing water for 15 minutes, and seek medical help. Skin contact: Rinse contacted area thoroughly with soap and water, and seek medical help. Ingestion: Vomiting, and seek medical help.
On fire	It's hard for battery system ignite spontaneously. If the battery has caught a fire, do not try to extinguish the fire but evacuate people immediately.
Wet Packs	If the battery system is soaked or submerged in water, do not access it. Contact Growatt or distributors immediately for technical assistance.
Damaged shell	Damage to the shell is very dangerous, so special attention must be paid. They are no longer suitable for use and may be dangerous to personnel. If the battery case is damaged, please stop using it and contact Growatt or a distributor.

## 3.1 Storage Requirements

- Place the product follow the identification on the packing case during storage.
- Do not put the product upside down or sidelong.
- The defective product needs to be separated from other product.
- The storage environment requirements are as follows:
  - Place the product in a dry, clean and well ventilated place.
  - The storage temperature for a short week (7 days) is between -30°C to 50°C.
  - If you store the product over a long period of six months, the storage temperature is between -20°C to 45°C, relative humidity: 5%~95%RH.
  - Place the product away from corrosive and organic substances (including gas exposure).
    - Free from direct exposure to sunlight and rain.
    - At least two meters away from heat sources (such as a radiator) .
    - Free from exposure to intensive infrared radiation.
- If the battery is stored for more than six months, the battery pack shall be recharged to 40% SOC every six months using a charger.



Notice



If not follow the above instructions for long-term storage, the battery cycle life will be reduced or even damaged.

## 3.2 Transportation Requirement

Battery pack has been certified in UN38.3 (Section 38.3 of the sixth Revised Edition of the Recommendations on the Transport of Dangerous Goods: Manual of Tests and Criteria) and SN/T 0370.2-2009 (Part 2: Performance Test of the Rules for the Inspection of Packaging for Exporting Dangerous Goods). Battery pack is classified as category 9 dangerous goods.

- The battery pack shall not be transported with other inflammable, explosive or toxic substances.
- Ensure the original Package and label complete and recognizable.
- Prohibit direct exposure to sunlight, rain, condensing water caused by temperature difference and mechanical damages.
- Prohibit to pile up more than six battery pack.
- There will be a drop in capacity during transportation and storage.
- Transportation temperature is between -20°C to 45°C, relative humidity: 5%~95%RH.

# 4 Installation

 <p><b>WARNING</b></p>	<ul style="list-style-type: none"> <li>➤ The installation and use of batteries involve a lot of expertise. Therefore, please ensure that technicians have obtained relevant technical certificates before operation.</li> <li>➤ Ensure to read the Guidance before installation in order to understand product information and safety cautions.</li> <li>➤ Operators should be well trained technicians and fully understand the whole photovoltaic system, grid network, battery system, working principle and national regional standards.</li> <li>➤ Installers must use insulating tools and wear safety equipment.</li> <li>➤ Device damages caused by failure to comply with storage, transportation, installation and use requirements specified in Guidance are not covered by Warranty.</li> <li>➤ Do not install or use battery near explosive or inflammable substances.</li> <li>➤ Use battery in well-ventilated environment with temperature ranging from -10°C to 50°C.</li> <li>➤ Maintain a minimum level of dust and dirt in the environment.</li> <li>➤ Do not install battery in highly humid area such as bathroom.</li> <li>➤ Please make sure that all battery pack connected in series are from the same batch, the same model and the same manufacturer. Do not mix old batteries with new batteries. A battery pack that does not exceed 200 cycles is defined as a new battery.</li> </ul>
 <p><b>Notice</b></p>	<ul style="list-style-type: none"> <li>➤ Before installing in series, make sure that the voltage difference of the battery pack must be less than or equal to 0.5V.</li> <li>➤ When installing the batteries, we recommend that the manufacturing date of batteries in the same system should be within 3 months. The manufacturing date of batteries can be interpreted through bar code (refer to Appendix 1).</li> </ul>

## 4.1 Installation environment

➤ The battery system can be installed indoors or outdoors. The following conditions are allowed:

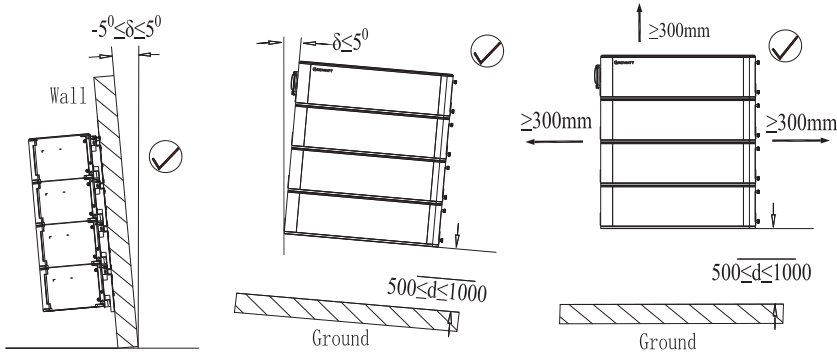

Fig 4.1: Acceptable wall mounted installation

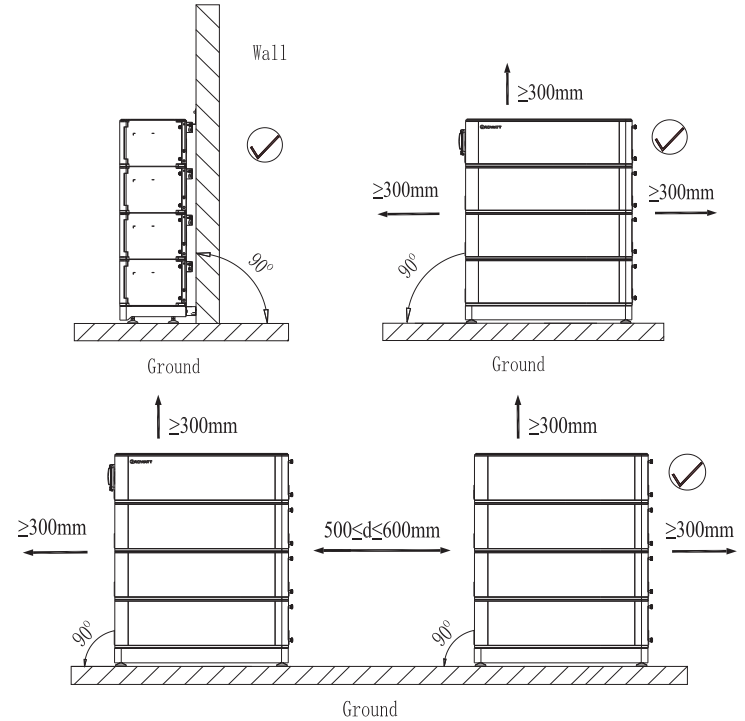



Fig 4.2: Acceptable floor standing installation

 <p><b>WARNING</b></p>	<p>Do not place the battery pack upside down.</p>
--	---

➤ When installing outdoors, it is necessary to install sunshades and rain shelters to avoid direct exposure to sunlight and rain.

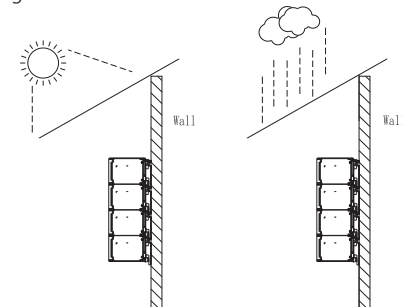
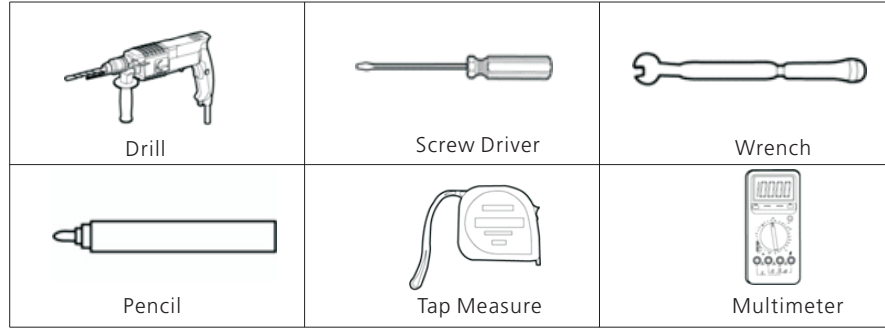

Fig 4.3: Sunshades and rain shelters

## 4.2 Installation Required Tools

The following tools are required to install the battery system:



It is recommended to wear the following safety gear when dealing with the battery system.



## 4.3 Installation Procedures

### 4.3.1 Pre-installation Check

- Check the PACK package before open it. If any abnormality is detected, do not open the Package and contact your distributor.
- Check the quantity of all parts inside according to the package list. If there is any part missing or damaged, please contact your distributor.

#### 4.3.1.1 Check the list of HVC 60050-A1

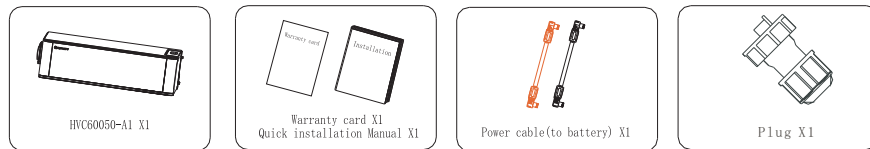

Fig 4.4: components and parts of HVC 60050-A1

#### 4.3.1.2 Check the list of ARK 2.5H-A1

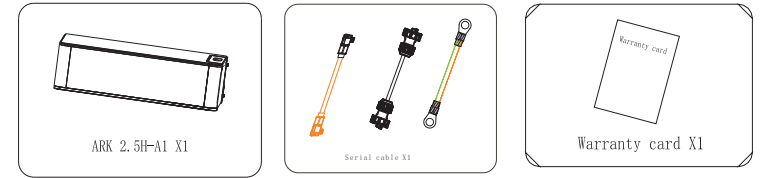

Fig 4.5: components and parts ARK 2.5H-A1

#### 4.3.1.3 Check the battery base and wall bracket

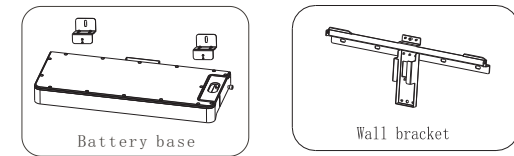

Fig 4.6: Optional installation accessories



Notice

- The high voltage controller (HVC 60050-A1) and the battery pack (ARK 2.5H-A1) are standard accessories, please be sure to purchase both, a battery system only needs a high voltage controller (HVC 60050-A1), battery pack (ARK 2.5H-A1) You can freely match the number within 2 to 10 .
- The battery base is only used for floor installation, and the wall bracket is only used for wall installation .The battery base and wall bracket are optional accessory, not standard accessory.
- You need to separately purchase the connection cable from the high voltage controller (HVC 60050-A1) to the PCS.
- If you want to install the same battery system in two lines, you need to purchase a extension cable separately for connection.
- The installation method can be selected wall Mounted installation or floor standing installation as required.



### 4.3.2 Wall Mounted Installation

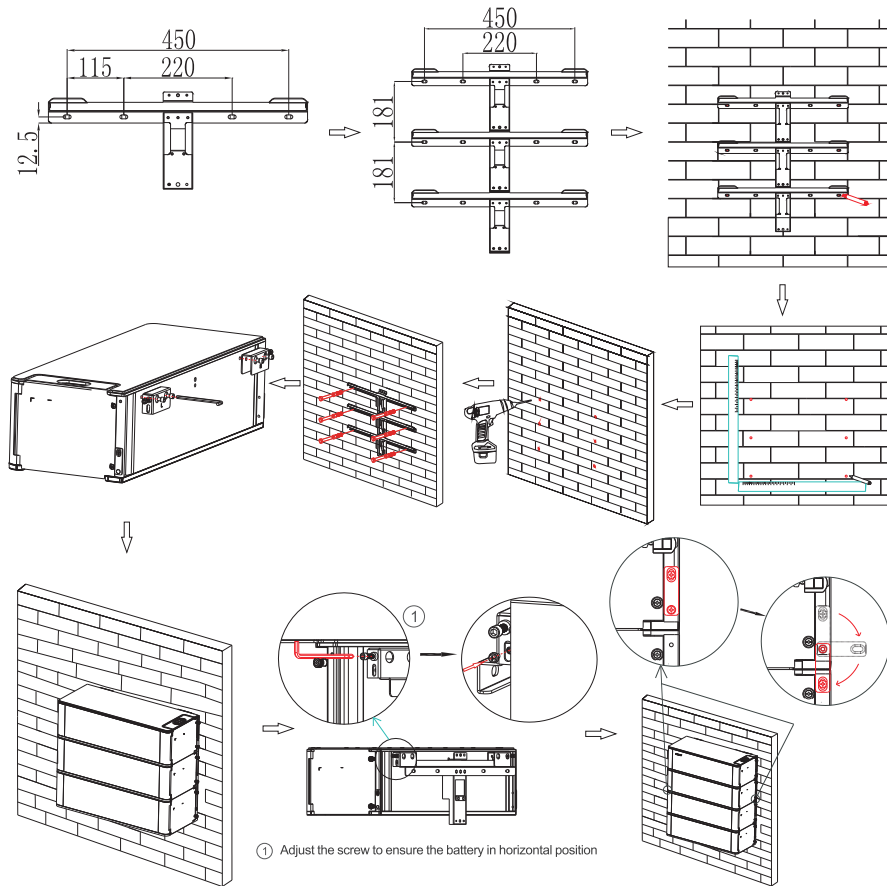

- Step 1: Please make sure that the weight capacity of the wall should exceed 150kg.
- Step 2: Put bracket on wall and mark drilling spots. Keep a minimum distance of 300mm between the wall and bracket; a minimum distance of 500mm between bracket and ground.
- Step 3: Choose an alloy drill with a diameter of 8mm, and drill at least 60mm mounting holes in the wall. Clean the soil and insert the expansion tube into the hole, then screw in the screw to fix the wall mount.
- Step 4: Fix the battery on the wall mount, make sure that the battery will not shake, and then lock the safety screw.



Notice

- The number of wall-mounted installations should not exceed 4 (including high voltage controllers).
- If there are more than 4, please install them in two lines, and the spacing should be greater than or equal to 300mm.

### 4.3.3 Floor Standing Installation

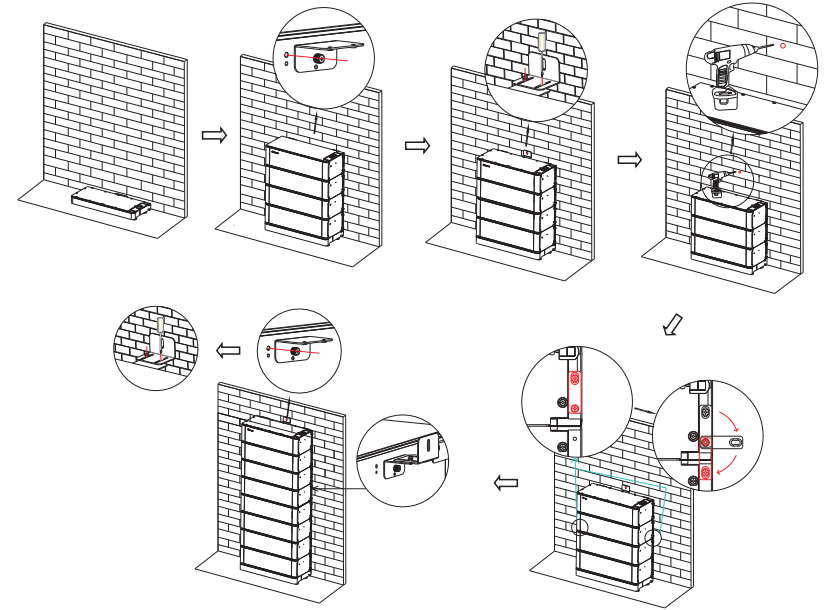

Fig 4.8: Floor standing installation process

- Step 1: Place the battery base in the area to be installed, and mark the position of the installation hole with a marker. The minimum distance between the wall and the battery is 300mm.
- Step 2: Select an alloy drill with a diameter of 10mm and drill a mounting hole at least 60mm deep in the wall. Insert the expansion pipe into the hole and screw in the screws to secure the anti roll over plate.
- Step 3: Stack the battery on the base, connect the fixed connecting strip between the battery packs.
- Step 4: Make sure the battery will not shake, and then lock the safety screw.



Notice

- If more than 4 batteries are used, base mounting is recommended.
- For floor installation with base, the maximum stack number of the battery is ten. But if the battery number is greater than six, we recommend stacking them in two lines.
- The safety part needs to be installed at the top battery, however, once the number of the battery pack is higher than 7, one more safety part should be installed in the middle battery which is shown the last step.

### 4.4 Electrical Connection



Notice

- Do not forget wear ESD wrist strap and gloves, safety gloves and goggles.

#### 4.4.1 Definition of RJ45 communication port pin

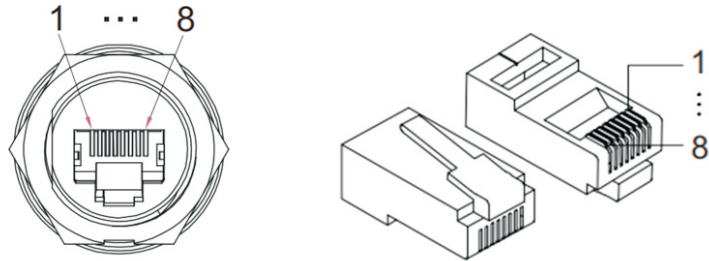

##### 4.4.1.1 Communication port definition of HVC 60050-A1

No.	PCS	LINK_IN	LINK_OUT	BMU
1	RS485_B	Add_in	Add_out	\
2	RS485_A	Master	GND	\
3	GND	GND	Slaver	IMA_isoSPI
4	CAN_H	GND	GND	IPA_isoSPI
5	CAN_L	CANH	CANH	IMB_isoSPI
6	GND	CANL	CANL	IPB_isoSPI
7	WAKE-	GND	GND	\
8	WAKE+	Power_ON	Power_ON	\

##### 4.4.1.2 Communication port definition of HVC 60050-A1

No.	LINK 0	LINK 1
1	\	\
2	\	\
3	\	\
4	\	\
5	IMA_isoSPI	IMB_isoSPI
6	IPA_isoSPI	IPB_isoSPI
7	\	\
8	\	\

#### 4.4.2 Definition of RJ45 communication port pin



Notice

- When connecting the power line, it must be the same color terminal to connect, otherwise there may be dangers such as short circuit.
- A DC circuit breaker has been installed in the high voltage controller. If you want to install a DC circuit breaker between the battery system and the PCS, you need to purchase it yourself according to the following specifications:
  - a. Voltage: 750Vdc/1000Vdc
  - b. Current: 63A

##### 4.4.2.1 System connection diagram

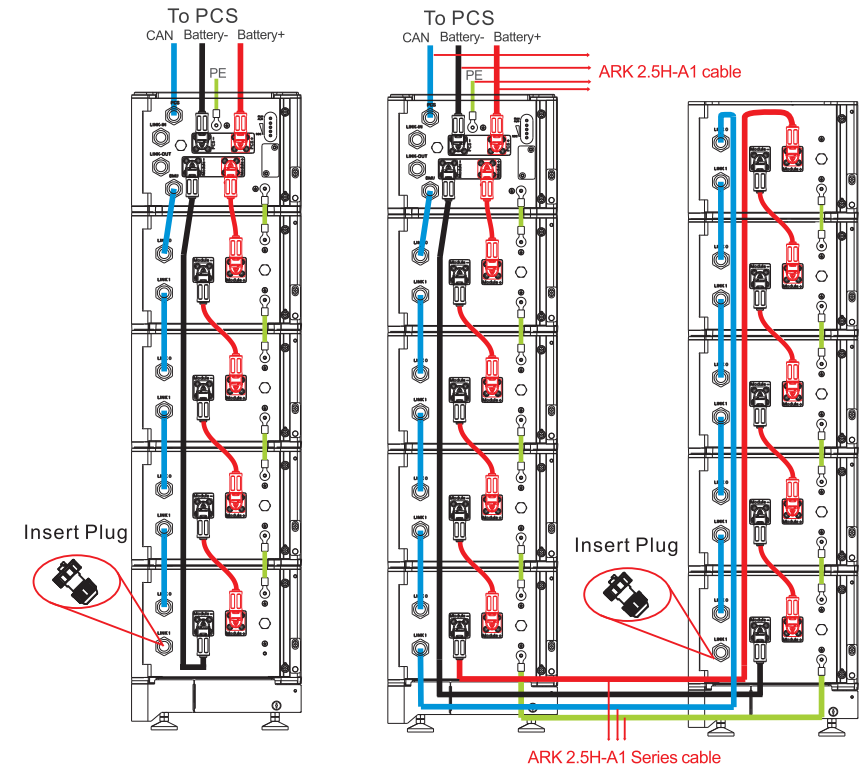

Fig 4.9: Single line installation

Fig 4.10: Two lines installation

##### Note:

- The battery is not allowed to be installed in the running state. Turn off the system power before installation.
- To ensure system security, do not forget to install ground wire.
- Don't forget to connect the communication plug of the last battery pack, otherwise it will cause system failure.
- When installing in two rows, please purchase the extended serial cable.
- The cable connecting PCS can be purchased from GROWATT.

#### 4.4.2.2 Electrical wiring connection

##### A. HVC 60050-A1(High Voltage Controller) wiring

Step 1: Insert the power cable into the corresponding port, then there is click sound indicating the connection is ok.

Step 2: Insert the communication cable into the "PCS" port and "BMU" port, and then tighten the communication terminal clockwise. ("PCS" port connects to the PCS. "BMU" port connects to the adjacent battery pack.)

Step 3: Connect to the PCS and adjacent battery pack using a 6mm<sup>2</sup> grounding wire through grounding terminal.

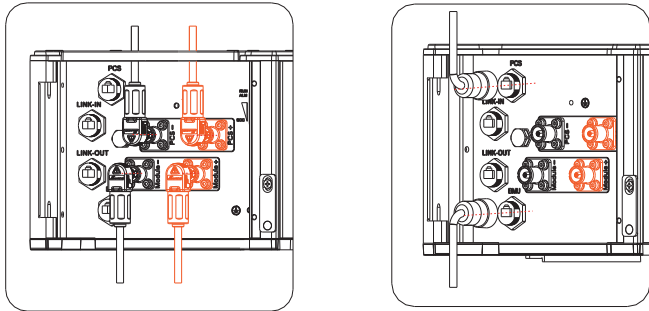

Fig 4.11: HVC60050-A1 Electrical wiring connection diagram



Notice

- For a single battery system, the "Link-in" and "Link out" port of the High Voltage Controller don't need to be connected, they are only used for parallel connection of the battery systems.
- Please pay attention to the connector color when connection the power line. Only the same color of the connector could be connected together.
- To ensure system security, do not forget to install ground wire.

##### B. ARK 2.5H-A1(Battery module) wiring

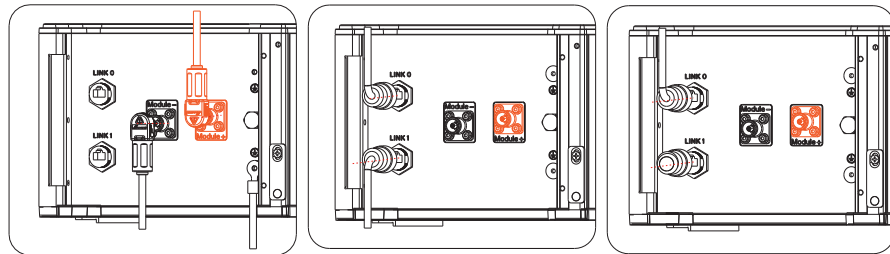

Fig 4.12: ARK 2.5H-A1 Electrical wiring connection diagram

Step 1: Insert the power cable into the corresponding port, then there is click sound indicating the connection is ok.

Step 2: Insert the communication cable into the "Link0" and "Link1" port, and then tighten the communication terminal clockwise. ("Link0" connects to "Link1" of the previous module. For the battery adjacent to the high voltage controller, "link0" is connected to the "BMU" of the high voltage controller. "Link1" connects to "Link0" of the next module.)

Step 3: Insert a plug into the "Link1" port of the last battery module. The plug is an annex of HVC 60050-A1 (high voltage controller).

Step 4: Connect to adjacent battery pack using a 6mm<sup>2</sup> grounding wire through grounding terminal.



Notice

- The battery module furthest from the HVC 60050-A1(high voltage controller) is defined as the last battery module.
- Please pay attention to the connector color when connecting the power line. Only the same color of the connector could be connected together.
- The power lines between the battery modules are connected in series. Be careful not to short-circuit the battery modules during the connection process.

# 5 Power on/off Battery system

**Notice**

- The installation and use of batteries need to be operated by professional technicians.
- Do not contact any positions with potential difference.
- Prohibition sign should be hung on the battery: " Non - professionals, do not touch.
- If any abnormalities occur during the startup phase, power off the system immediately. After problem confirmed, proceed again.
- Make sure the inverter is turned off before checking the battery system.

## 5.1 Power on Battery system

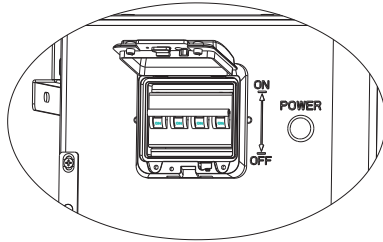

Fig 5.1

➤ Before turning on the battery, please check if the cable is properly connected.

Power on the battery system by pressing power button( $t > 5S$ )		
Serial	Procedures	Acceptation criteria
1	Connect the battery and PCS	Make sure the wiring harnesses are well connected
2	Close the breaker of the battery system	Make sure the breaker is ON
3	Press POWER button for 5 seconds. Observe the LED indication on panel..	1. If both RUN/ALM and SOC lights turn on normally, system is powered on successfully. 2. If RUN/ALM light turns red, there is a failure and should solve it before power on again.

## 5.2 Power off

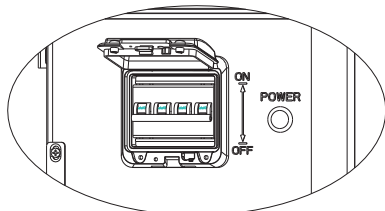

Fig 5.2

Turn the DC breaker of the HVC 60050-A1(High Voltage Controller) to "Off" to turn off the entire battery system.

# Maintenance Guide 6

## 6.1 Preparation

Before maintenance, please make sure that the battery system is powered off and the DC circuit breaker is off.

## 6.2 Battery pack or high voltage controller replacement

- Wear safety gloves.
- Close the breaker and power off the battery system.
- Disconnect power lines and CAN communication lines of the battery system.
- Uninstall the safety screws on both sides of the battery pack or high voltage controller. Lift up the battery pack or high voltage controller.
- Put the battery pack or high voltage controller into the packing box according to the repair procedure and transport the battery pack or high voltage controller to the designated repair site.
- Install new battery pack or high voltage controller based on procedure specified in Section 4.

**Notice**

- Before replacing the battery, use the charger to charge the new battery and the existing battery to full (SOC 100%).
- If the battery is not used, it is recommended to charge and discharge the battery every 3 months to activate the chemical characteristics, and the maximum interval shall not exceed 6 months.

## 6.3 System Failure Information List and Troubleshooting Suggestions

Error Indication	Error description	Error cause	Suggested actions
ALM  ( ALM Light Flickers )	Discharge under voltage protection	Single cell voltage below the threshold for under-voltage protection.	There is over discharge risk. User should stop discharging and arrange recharge
	Charge over voltage protection	Single cell voltage exceeding threshold for protection threshold.	1. There is no safety threat; 2. User should stop charging. Wait for the battery system to automatically resolve the fault
	External CAN Communication failure	Communication loss between PCS and battery system.	1. There is no safety threat and user should stop using battery. 2. Check if PCS and battery communication terminal is well connected. 3. If PCS and battery system cannot communicate when the communication wire is confirmed well connected, user should contact installer to repair battery.

# Technical Specifications7

	Interior Communication failure	Communication loss between two packs	1.Check whether the communication line between the battery pack and the battery pack is connected OK; 2.Check whether the communication line between the high voltage controller and the battery pack is connected OK.
	High temperature protection	The temperature exceeds the protection value	It is dangerous, please stop using the battery immediately, wait for the battery temperature to drop, the fault will be automatically resolved.
	Low temperature protection	The temperature is below the protection value	No safety risk, wait for the temperature to rise, the fault will be automatically resolved.
●(ALM Light on)	Discharge short circuit	External short circuit of battery system	There is safety risk and user should stop using battery. User should contact installer to repair PCS and battery.
	Precharge short circuit		
	Precharge overtime		
	Voltage sampling anomaly protection	BMS Voltage sampling failure	There is safety risk and user should stop using battery. User should contact installer to repair battery.
	Current sampling fault	BMS current sampling failure	
	Main circuit fault	BMS main power circuit failure	There is safety risk and user should stop using battery. User should contact installer to repair battery.

## 7.1 System Data

System Model	ARK 5.1H-A1	ARK 7.6H-A1	ARK 10.2H-A1	ARK 12.8H-A1	ARK 15.3H-A1
Nominal energy	5.12kWh	7.68kWh	10.24kWh	12.8kWh	15.36kWh
Rated energy	4.608kWh	6.912kWh	9.216kWh	11.52kWh	13.82kWh
Rated Power	2.56kw	3.84kw	5.12kw	6.4kw	7.68kw
Max Power	4.915kw	7.372kw	9.83kw	12.288kw	14.745kw
Nominal capacity	50Ah(@25℃)				
Rated capacity	45Ah(@25℃)				
Nominal voltage	102.4V	153.6V	204.8V	256V	307.2V
Voltage range	94.4V~113.6V	141.6V~170.4V	188.8V~227.2V	236V~284V	283.2V~340.8V
Dimensions (mm)	650/260/555	650/260/740	650/260/925	650/260/1110	650/260/1295
Weight	64kg	91kg	118kg	45kg	172kg
Rated current	25A(@25℃)				
Max current	48A(@25℃)				
Fault current	49A(@25℃)				
DoD	90%				
Operating ambient temperature	-10℃~50℃				
RTE	≥95%				
Battery pack in series	Maximum support 10 units in series, series voltage difference $\Delta V \leq 0.5V$				
Humidity	5%~95%				
Storage temperature	-30℃~50℃/7 days; -20℃~45℃/6 months; 95%RH				
cooling method	Natural cooling				
Installation	Wall-mounted/floor stacking installation				
Altitude	≤2000m				
communication method	CAN (to PCS)				
Certified product	IEC62619 / RCM+ CEC /CE				
Transport certification	UN38.3				
IP rating	IP65				
Environmental requirements	RoHS, Reach				
Battery System	Secondary Li-ion Battery System				
Warranty[1]	10 years				

[1]Conditions apply. Refer to GROWATT Warranty Card.

System Model	ARK 17.9H-A1	ARK 20.4H-A1	ARK 23.0H-A1	ARK 25.6H-A1
Nominal energy	17.92kWh	20.48kWh	23.04kWh	25.6kWh
Rated energy	16.13kWh	18.43kWh	20.74kWh	23.04kWh
Rated Power	8.96kw	10.24kw	11.52kw	12.8kw
Max Power	17.203kw	19.66kw	22.118kw	24.576kw
Nominal capacity	50Ah(@25°C)			
Rated capacity	45Ah(@25°C)			
Nominal voltage	358.4V	409.6V	460.8V	512V
Voltage range	330.4V~397.6V	377.6V~454.4V	424.8V~511.2V	472V~568V
Dimensions (mm)	650/260/1480	650/260/1665	650/260/1850	650/260/2035
Weight	199kg	226kg	253kg	280kg
Rated current	25A(@25°C)			
Max current	48A(@25°C)			
Fault current	49A(@25°C)			
DoD	90%			
Operating ambient temperature	-10°C~50°C			
RTE	≥95%			
Battery pack in series	Maximum support 10 units in series, series voltage difference $\Delta V \leq 0.5V$			
Humidity	5%~95%			
Storage temperature	-30°C~50°C/7 days; -20°C~45°C/6 months; 95%RH			
cooling method	Natural cooling			
Installation	Wall-mounted/floor stacking installation			
Altitude	≤2000m			
communication method	CAN (to PCS)			
Certified product	IEC62619 / RCM+ CEC /CE			
Transport certification	UN38.3			
IP rating	IP65			
Environmental requirements	RoHS, Reach			
Battery System	Secondary Li-ion Battery System			
Warranty[1]	10 years			

[1]Conditions apply. Refer to GROWATT Warranty Card.



Notice

- Method for calculating rated capacity:  
Rated capacity of the measured module: 45 Ah  
Number of modules connected in series: 2~10  
Calculated rated capacity (Ah) = 45 Ah \* 1 = 45Ah
- The performance will be limited when the temperature is below 0°C.

## 7.2 Battery System designation

Model	Battery designation	Recommended charge instructions
ARK 5.1H-A1	IFpP/41/150/102/[(1P16S)2S]M/-10+50/90	1.Constant current 25A charging to 108V; 2.Constant current 10A charging to 110V; 3.Constant current 2A charging to 110V;
ARK 7.6H-A1	IFpP/41/150/102/[(1P16S)3S]M/-10+50/90	1.Constant current 25A charging to 162V; 2.Constant current 10A charging to 165V; 3.Constant current 2A charging to 165V;
ARK 10.2H-A1	IFpP/41/150/102/[(1P16S)4S]M/-10+50/90	1.Constant current 25A charging to 216V; 2.Constant current 10A charging to 220V; 3.Constant current 2A charging to 220V;
ARK 12.8H-A1	IFpP/41/150/102/[(1P16S)5S]M/-10+50/90	1.Constant current 25A charging to 270V; 2.Constant current 10A charging to 275V; 3.Constant current 2A charging to 275V;
ARK 15.3H-A1	IFpP/41/150/102/[(1P16S)6S]M/-10+50/90	1.Constant current 25A charging to 324V; 2.Constant current 10A charging to 330V; 3.Constant current 2A charging to 330V;
ARK 17.9H-A1	IFpP/41/150/102/[(1P16S)7S]M/-10+50/90	1.Constant current 25A charging to 378V; 2.Constant current 10A charging to 385V; 3.Constant current 2A charging to 385V;
ARK 20.4H-A1	IFpP/41/150/102/[(1P16S)8S]M/-10+50/90	1.Constant current 25A charging to 432V; 2.Constant current 10A charging to 440V; 3.Constant current 2A charging to 440V;
ARK 23.0H-A1	IFpP/41/150/102/[(1P16S)9S]M/-10+50/90	1.Constant current 25A charging to 486V; 2.Constant current 10A charging to 495V; 3.Constant current 2A charging to 495V;
ARK 25.6H-A1	IFpP/41/150/102/[(1P16S)10S]M/-10+50/90	1.Constant current 25A charging to 540V; 2.Constant current 10A charging to 550V; 3.Constant current 2A charging to 550V;



## 7.3 HVC 60050-A1

No.	Items	Specification
1	Model	HVC 60050-A1
2	Input/output voltage range	90~585V
3	Rated current	25A
4	Operating ambient temperature	-10~50 C
5	IP rating	IP65
6	Warranty	≥10 years
7	communication method	CAN2.0
8	Dimensions (W/D/H)	W650*D260*H185 mm ±2mm
9	Weight	8.5±1kg
10	Certification	CE-EMC
11	Environmental requirements	RoHS

## 7.4 ARK 2.5H-A1

No.	Items	Specification
1	Battery pack Module	ARK 2.5H-A1
2	Nominal Capacity/Energy	50Ah/2.56kWh
3	Rated Capacity/Energy	45Ah/2.3 kWh
4	Nominal Voltage	51.2V
5	Operating Voltage	47.2 - 56.8V
6	Rated current(25 C)	25A
7	Battery Type	Cobalt Free Lithium Iron Phosphate (LFP)
8	Operating ambient temperature	-10~50 C
9	Storage conditions	-30 C~50 C/7 days; -20 C~45 C /6 months; 95%RH
10	Cooling	Natural cooling
11	Dimension (W/D/H)	W650*D260*H185 mm ±2mm
12	Weight	27±1kg
13	Installation	Wall-mounted installation/floor standing installation
14	Warranty	10 Years
15	Ingress protection	IP65
16	Cell safety certification	IEC62619/UL1642
17	safety certification	IEC62619/CE/RCM/ CEC
18	Transportation test standard	UN38.3
19	Environmental requirements	RoHS
20	Battery designation	IFpP/41/150/102/[1P16S]M/-10+50/90

## ➤ Barcode coding rules

### Bar code number position:

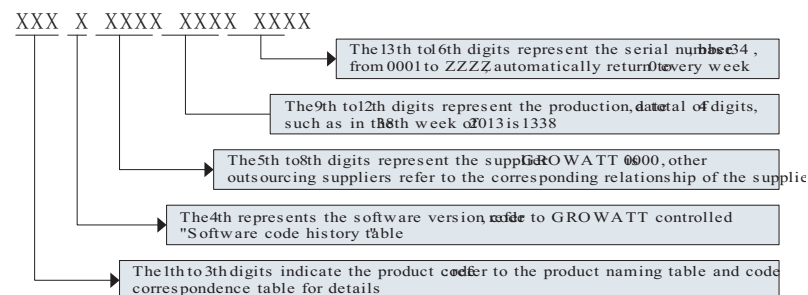

1. The 1st to 3rd digits indicate the product code : refer to the product naming table and code correspondence table for details.
2. The 4th digit represents the software version code , refer to GROWATT controlled "Software code history table" .
3. The 5th to 8th digits represent the supplier code. GROWATT is 0000, the supplier D is 0001, and other outsourced suppliers are 0002/0003... , and so on, please refer to the corresponding relationship table of the supplier code.
4. The 9th to 12th digits represent the production date, which is represented by 4 digits, the year is represented by the first 2 digits, and the week is represented by the last 2 digits, for example, the 38th week of 2013 is 1338.
5. The 13th to 16th digits represent the serial number, 34 base , represented by 4 digits, and the characters 0 to Z are used. I and O in the letters are discarded.  
For example, the product number is SD00.0002100, the product code is ARJ, the software version is 0, the supplier D is 0001, the production date is 21th week in 2021, and the first barcode of the work order is ARJ0000121210001.



# Appendix II

## LED indication Control Mechanism

LED light definition							
Status	Items	SOC indication				RUN/ALM	Remark
		LED1	LED2	LED3	LED4	LED5	
Charge SOC	0%-25%	✱(t=1S)				●	RUN/ALM light on and one SOC lights flicker
	26%-50%	●	✱(t=1S)			●	
	51%-75%	●	●	✱(t=1S)		●	
	76%-99%	●	●	●	✱(t=1S)	●	
	100%	●	●	●	●	●	
Discharge SOC	100%-76%	●	●	●	●	●	
	75%-51%	●	●	●		●	
	50%-26%	●	●			●	
	25%-5%	●				●	
	5%-0%	●				✱(t=1S)	RUN/ALM light flicker
Idle	100%-76%	●	●	●	●	●	
	75%-51%	●	●	●		●	
	50%-26%	●	●			●	
	25%-5%	●				●	
	5%-0%	●				✱(t=1S)	RUN/ALM light flicker
Protection	Cell charge overvoltage alarm	LED1-LED4 indicates current remaining capacity				✱(t=1S)	RUN/ALM light flicker green
	Cell charge overvoltage protection					✱(t=1S)	RUN/ALM light flicker green
	Cell discharge undervoltage alarm					✱(t=1S)	RUN/ALM light flicker green
	Cell discharge undervoltage protection					✱(t=1S)	RUN/ALM light flicker green
	Charge and discharge high temperature alarm					✱(t=1S)	RUN/ALM light flicker green

Charge and discharge high temperature protection	✱(t=1S)	RUN/ALM light flicker green
Charge and discharge low temperature alarm	✱(t=1S)	RUN/ALM light flicker green
Charge and discharge low temperature protection	✱(t=1S)	RUN/ALM light flicker green
PACK charge overvoltage alarm	✱(t=1S)	RUN/ALM light flicker green
PACK charge overvoltage protection	✱(t=1S)	RUN/ALM light flicker green
PACK discharge undervoltage alarm	✱(t=1S)	RUN/ALM light flicker green
PACK discharge undervoltage protection	✱(t=1S)	RUN/ALM light flicker green
High temperature environment alarm	✱(t=1S)	RUN/ALM light flicker green
High temperature environment protection	✱(t=1S)	RUN/ALM light flicker green
Cell Large voltage difference alarm	✱(t=1S)	RUN/ALM light flicker green
Cell Large voltage difference protection	✱(t=1S)	RUN/ALM light flicker green



	Warning of high temperature difference of PACK module		✱ (t=1S)	RUN/ALM light flicker green
Fault, personnel handling required	Discharge short circuit	SOC indicates current remaining capacity	✱ (t=1S)	RUN/ALM light flicker red
	Precharge short circuit		✱ (t=1S)	RUN/ALM light flicker red
	Precharge overtime circuit		✱ (t=1S)	RUN/ALM light flicker red
	External CAN communication failure		✱ (t=1S)	RUN/ALM light flicker red
	Interior communication failure		✱ (t=1S)	RUN/ALM light flicker red
	Voltage sampling anomaly protection		● (t=1S)	RUN/ALM light stays red
	Current sampling fault		● (t=1S)	RUN/ALM light stays red
	Main circuit fault		● (t=1S)	RUN/ALM light stays red

**Shenzhen Growatt New Energy Co., Ltd**

4-13/F, Building A, Sino-German (Europe) Industrial Park,  
Hangcheng Ave, Bao'an District, Shenzhen, China

**T** +86 755 2747 1942

**E** service@ginverter.com

**W** www.ginverter.com